

25 MODELS

301 PIECES

AGE 7 +

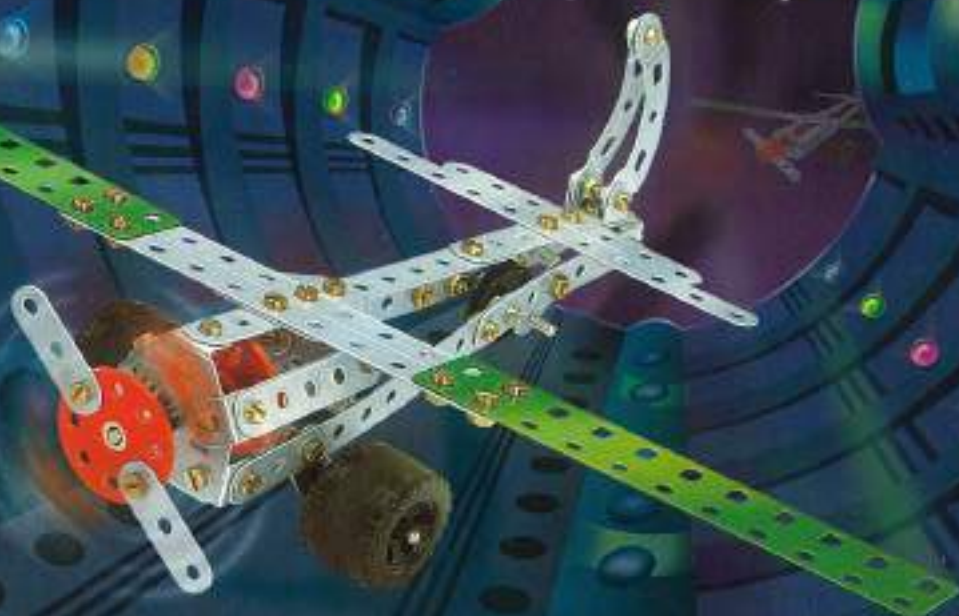

Do-it yourself manual

BASIC FITTINGS



Dear Friends !
Zephyr brings yet another International class engineering set of Mechanix for you. To have fun & learn. This set contains 240 pieces, crafted from high quality Steel, which are powder coated, superior plastics & selected tools which will be friendly to your little hands so that you have fun while creating various models. You can use these parts over & over again to create at least 25 models and may be many more as far as your imagination flies. So come on get started!

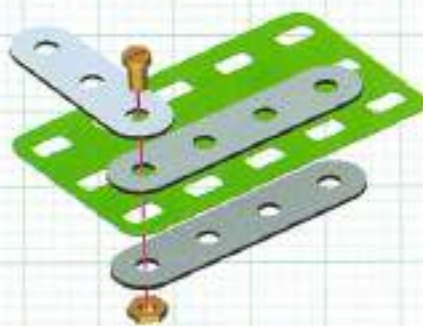
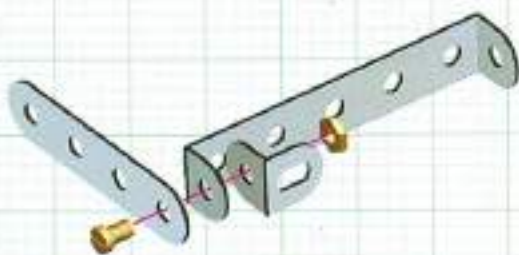
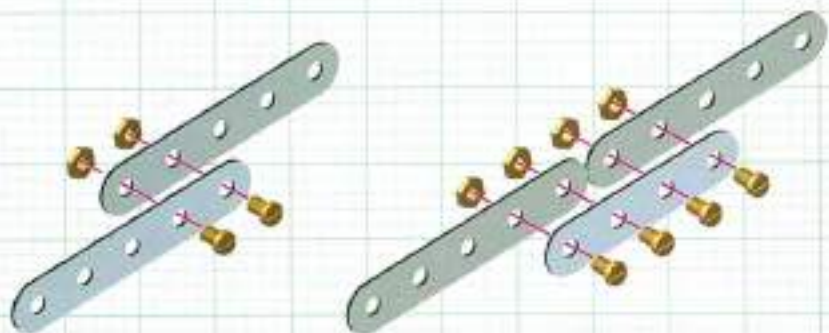
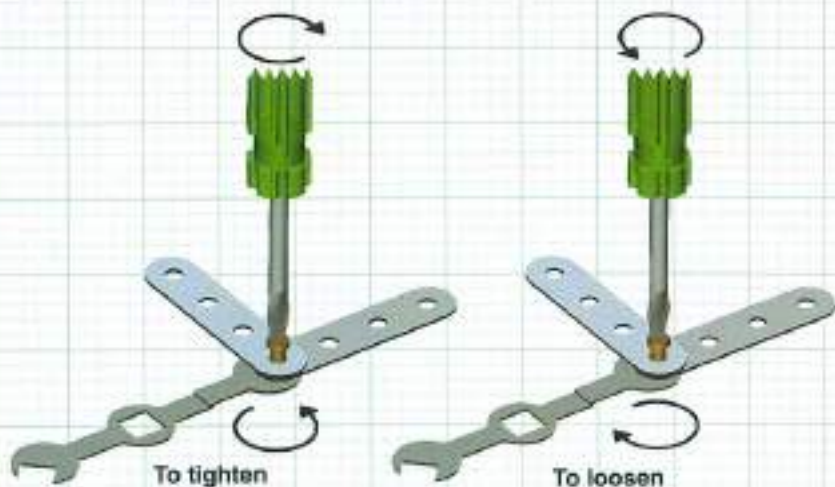



1



A-11 | 2 pcs.



A-5 | 1 pc.



SQ-25 | 1 pc.



BTB-5 | 2 pcs.



AB-2 | 2 pcs.



AZS-3 | 1 pc.



BOLTS | 8 pcs.



NUTS | 8 pcs.

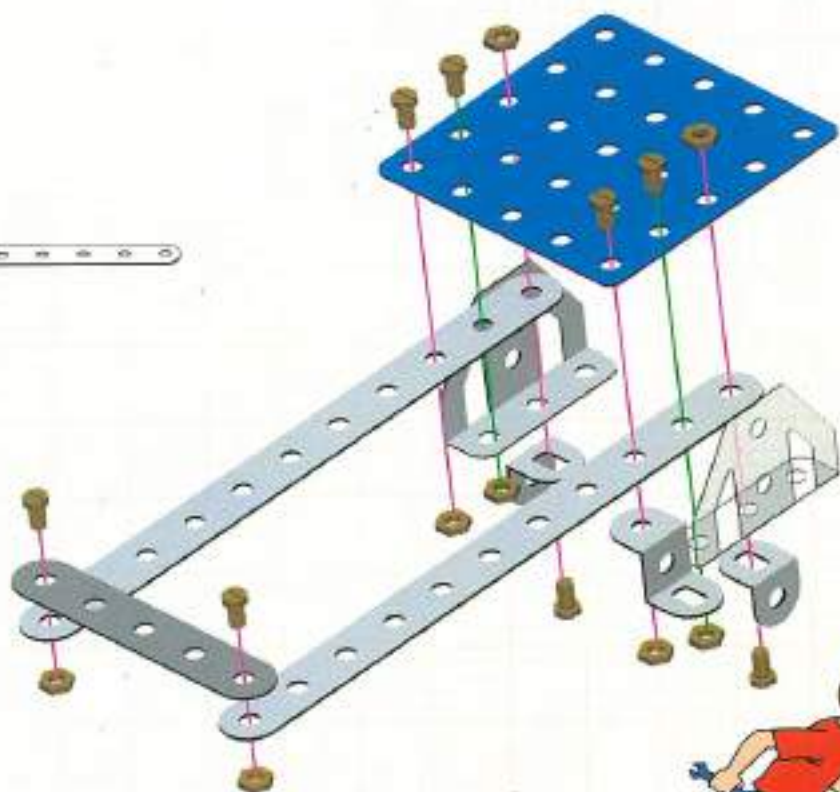

2



NUTS | 4 pcs.



BOLTS | 4 pcs.



AB-2 | 2 pcs.

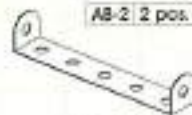

AB-7 | 2 pcs.

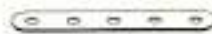

A-5 | 1 pc.

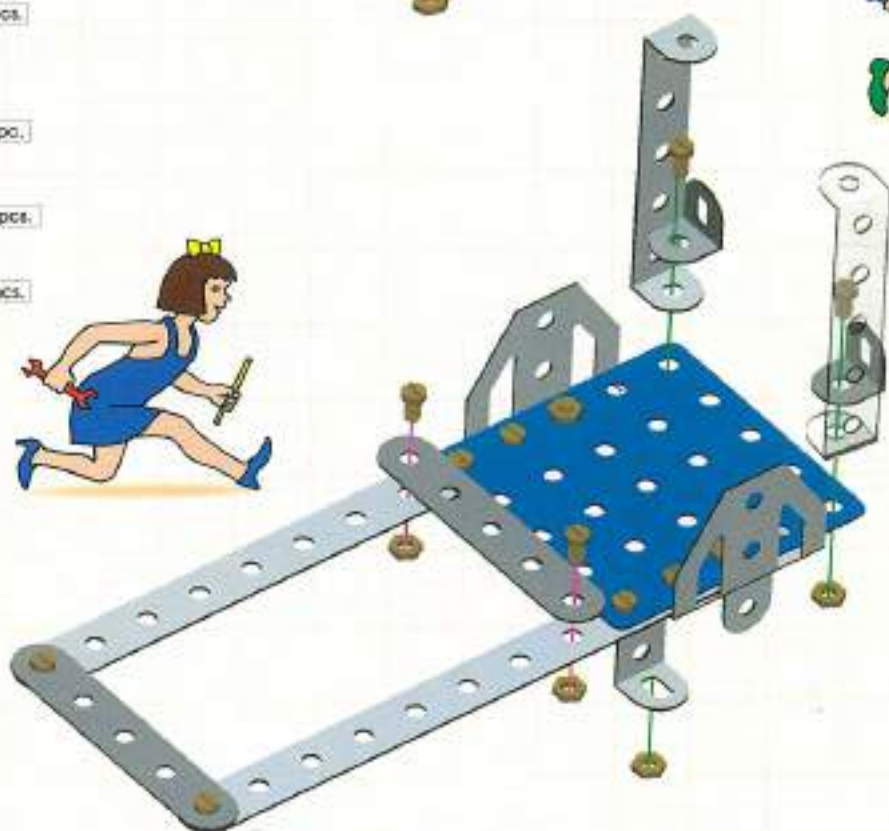

3



SQ-25 1 pc.

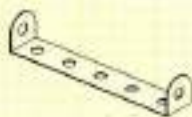

AB-7 2 pcs.

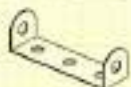

AB-5 1 pc.



A-3 1 pc.



AB-2 1 pc.



BOLTS 6 pcs.



NUTS 6 pcs.

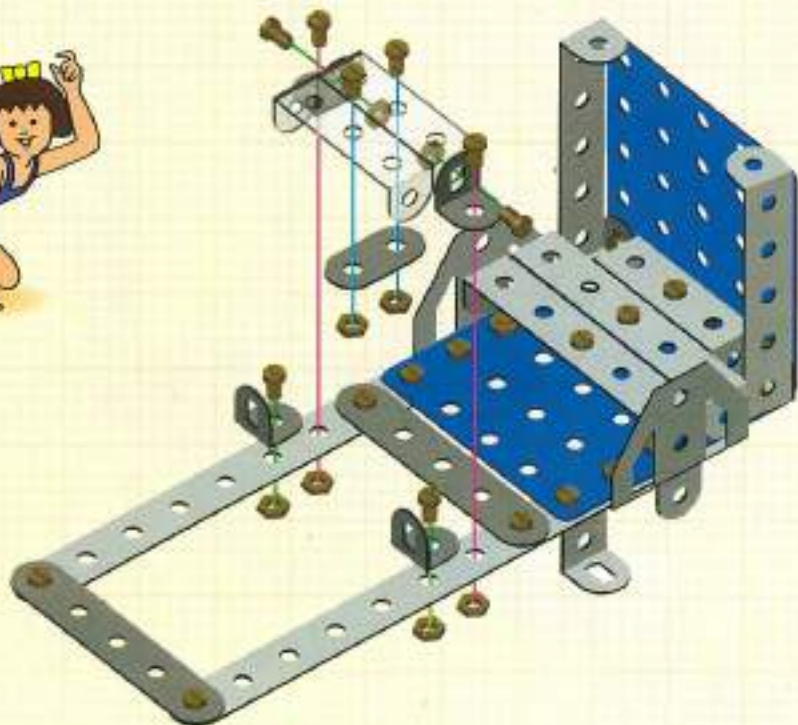
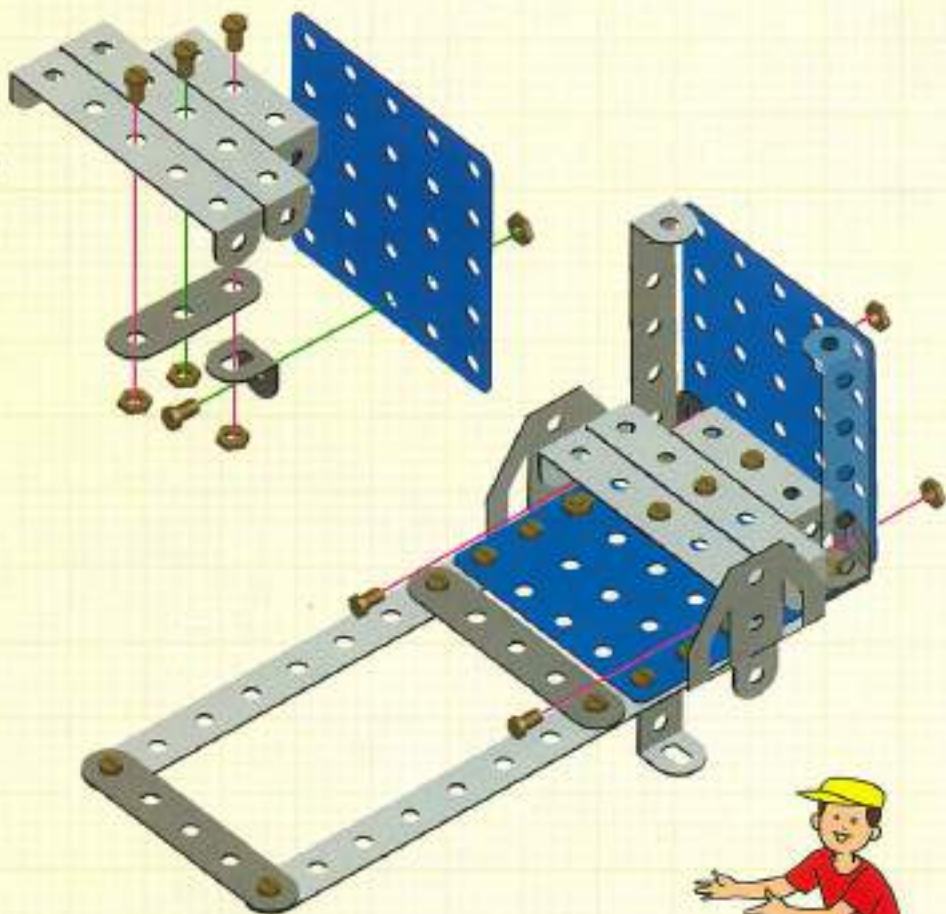

4



NUT 8 pcs.



BOLT 8 pcs.



AB-2 4 pcs.



A-2 1 pc.

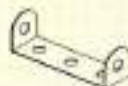

AB-5 2 pcs.

5

SH-4 1 pc.



T8-26 1 pc.



PSR-12 1 pc.



A-5 2 pcs.



A-5 2 pcs.



WHEELS 2 pcs.



TW-1 2 pcs.



BOLTS 6 pcs.



NUTS 6 pcs.

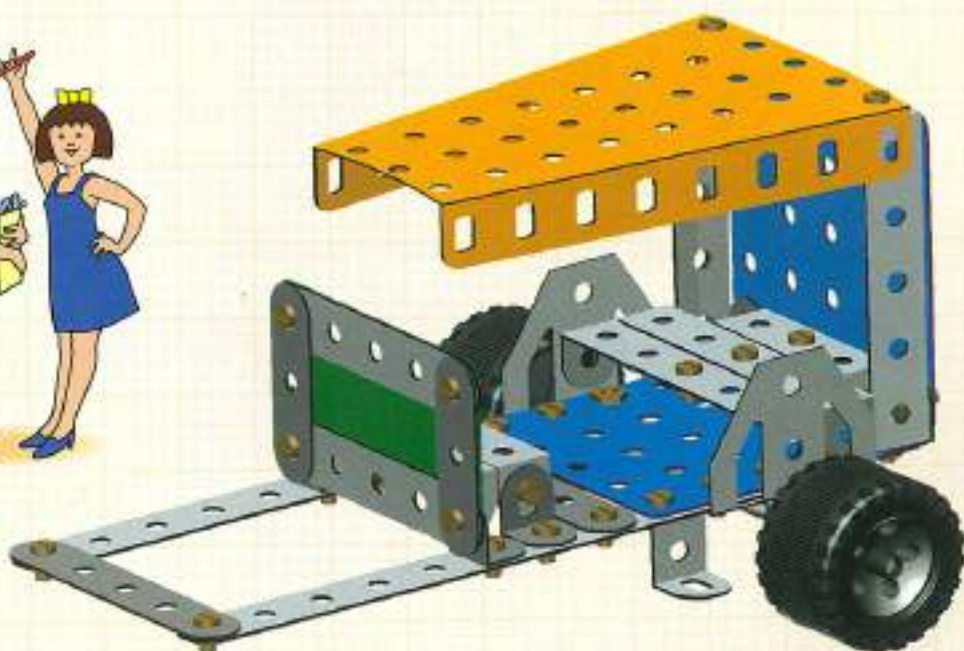
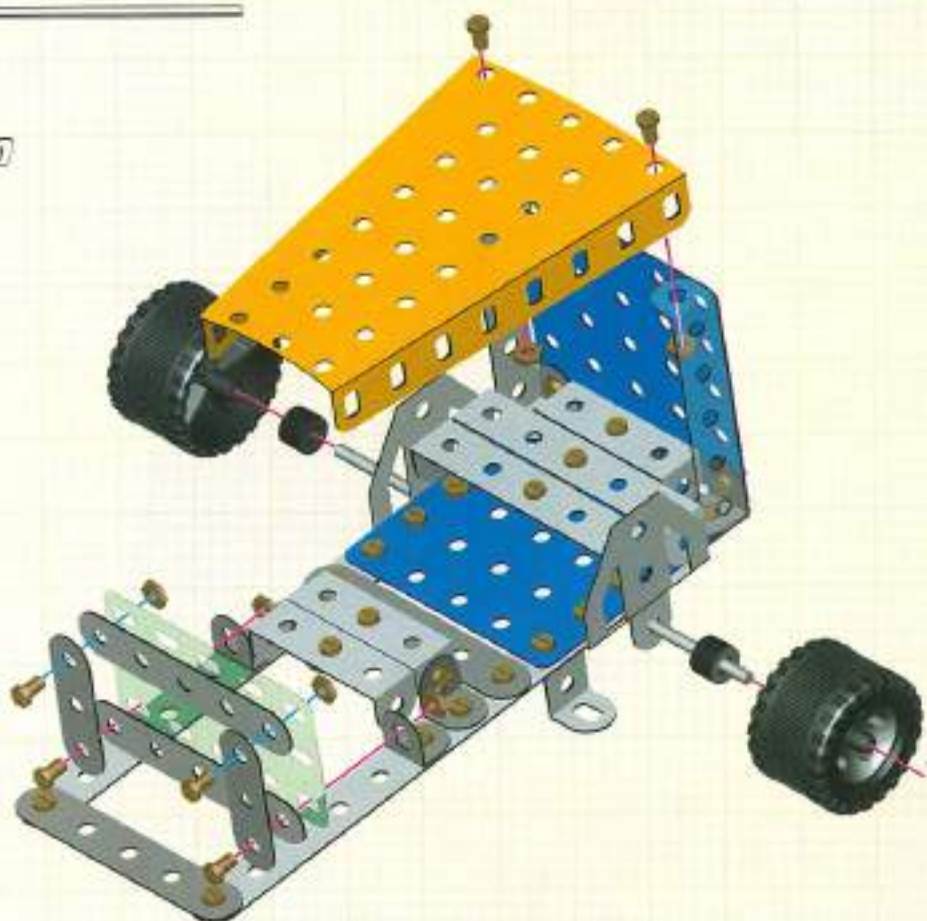



1



9Q-25 | 1 pc.



W-8 | 2 pcs.

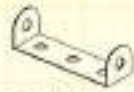

AB-5 | 2 pcs.



AB-2 | 3 pcs.



AB-3 | 1 pc.



NUTS | 8 pcs.



BOLTS | 8 pcs.

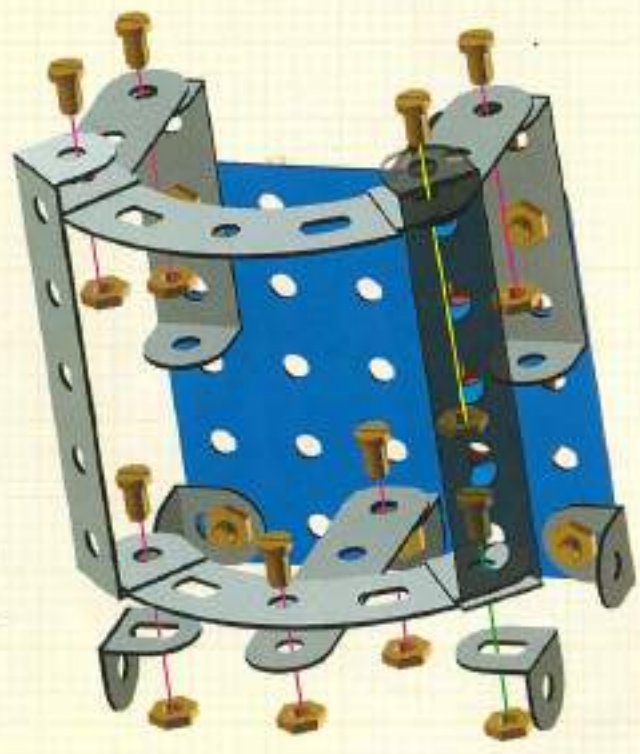
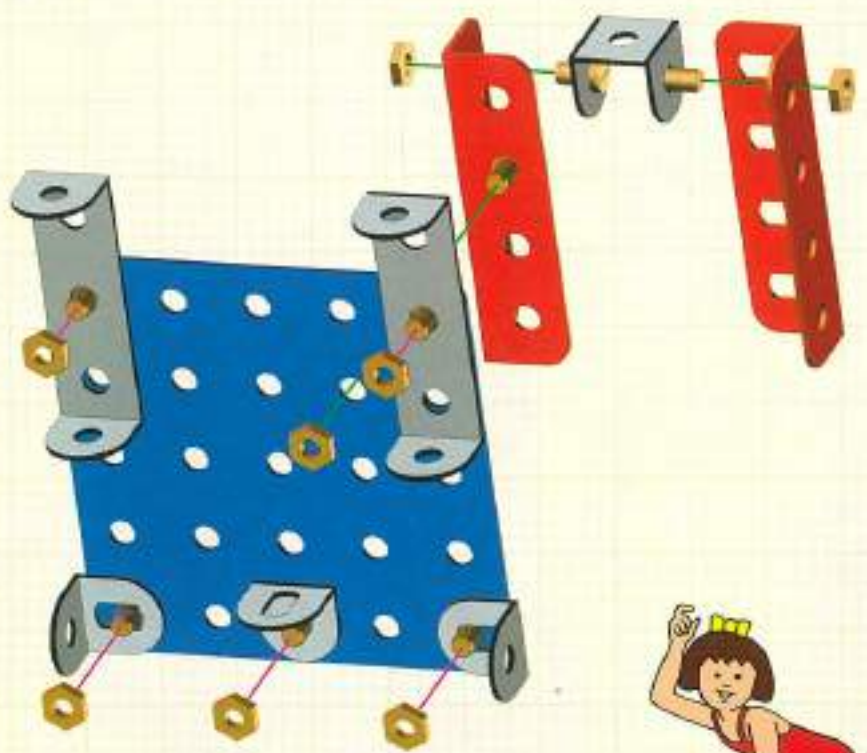

2



NUTS | 8 pcs.



BOLTS | 8 pcs.



AB-2 | 2 pcs.

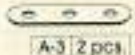

A-3 | 2 pcs.

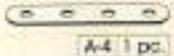

A-4 | 1 pc.

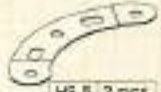

HS-8 | 2 pcs.



AB-7 | 2 pcs.

3

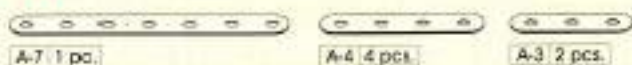

SH-4 1 pc.

SH-2 1 pc.

SH-1 2 pcs.



WHEELS 2 pcs.



R-8 1 pc.



PV-2 2 pcs.



PV-1 2 pcs.



AUB-5 1 pc.



AB-2 3 pcs.



TW-1 1 pc.



U-CLIP 7 pcs.



NUTS 13 pcs.



BOLTS 12 pcs.



LONG BOLTS 2 pcs.

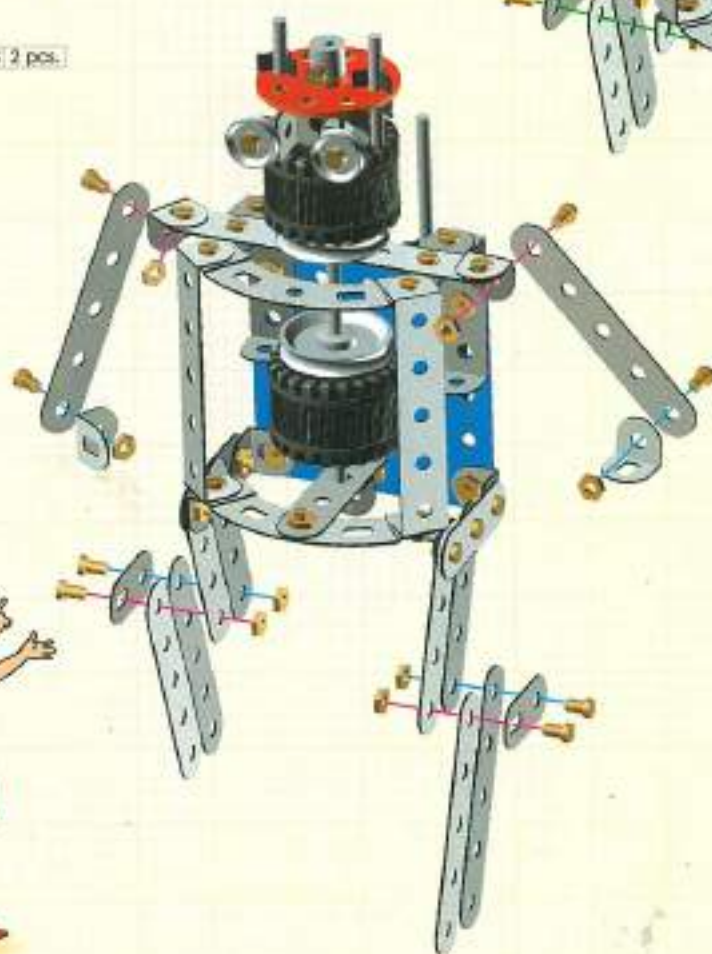
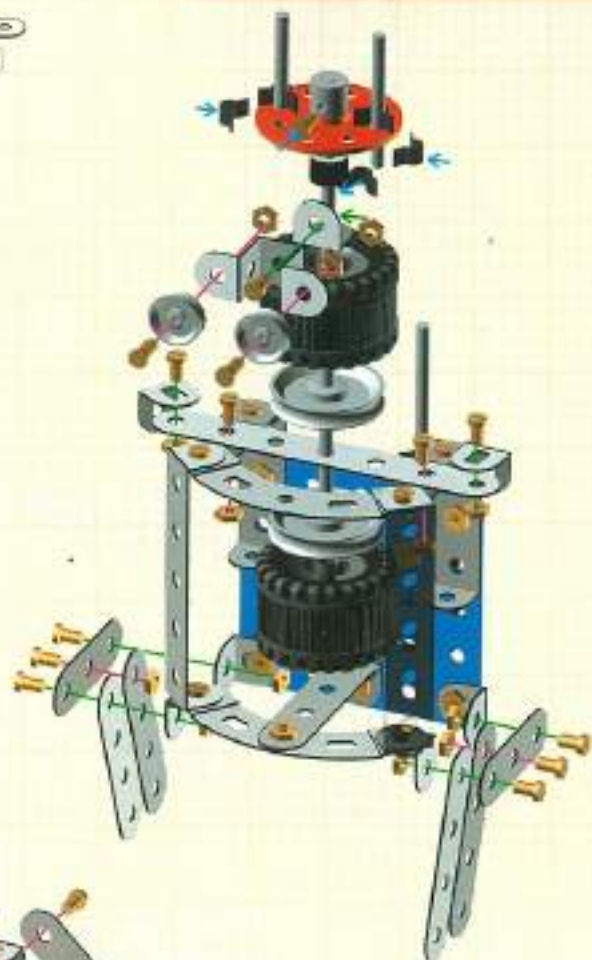

4

NUTS 8 pcs.

BOLTS 8 pcs.

AB-2 2 pcs.

A-2 2 pcs.

A-5 6 pcs.

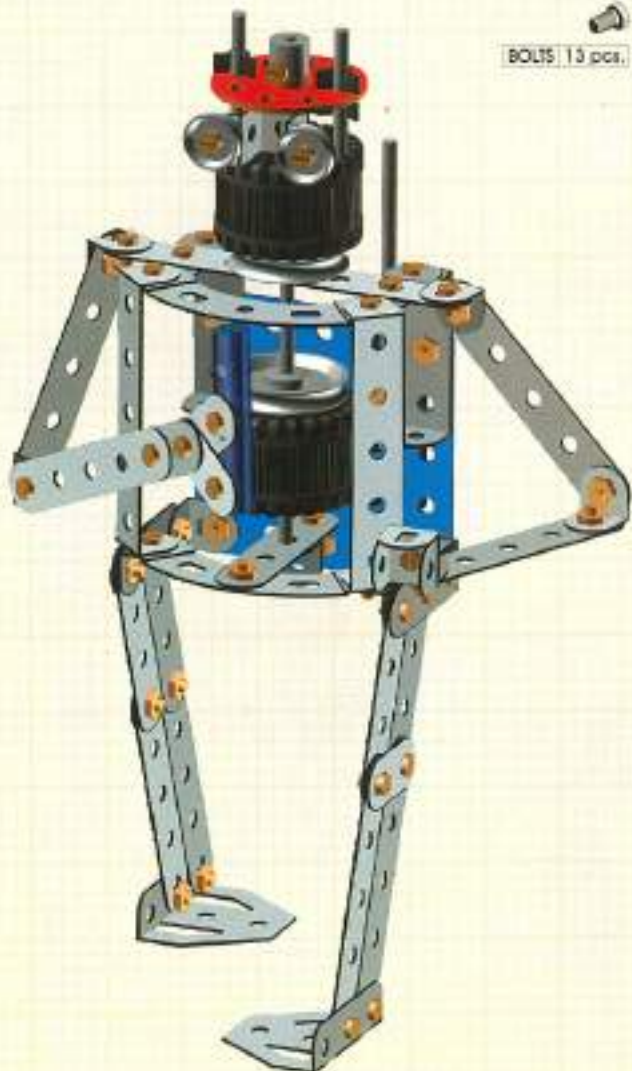
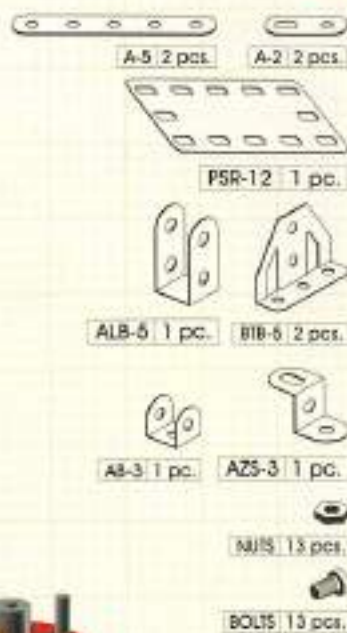
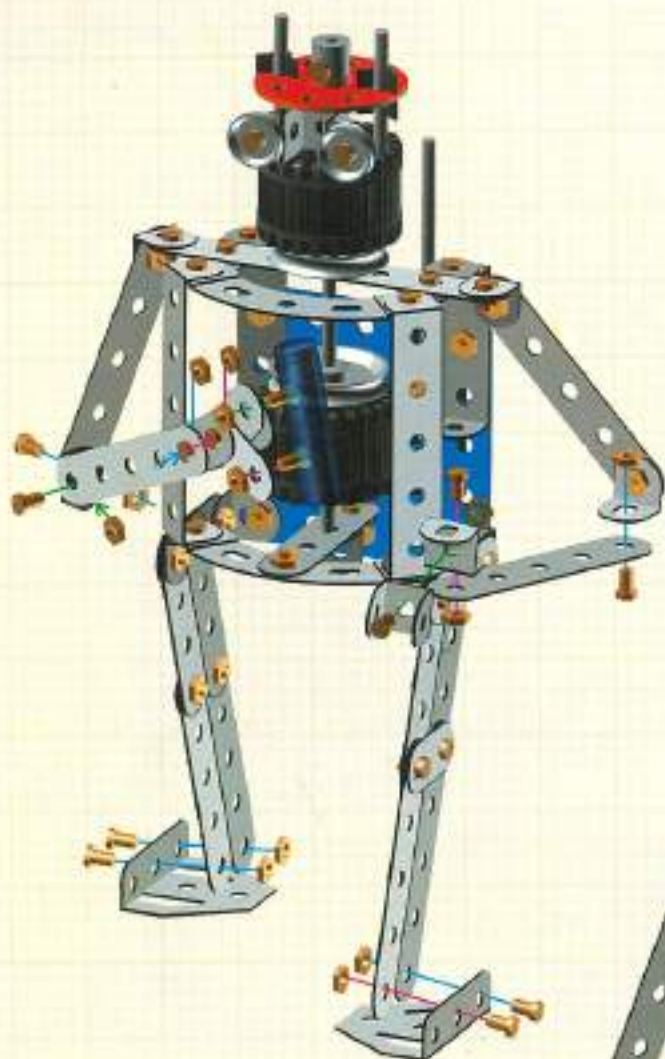



1



RT-66 1 pc.

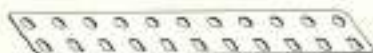

BLR-11 2 pcs.



SG-25 1 pc.



AB-2 2 pcs.



BOLTS 8 pcs.



NUTS 8 pcs.

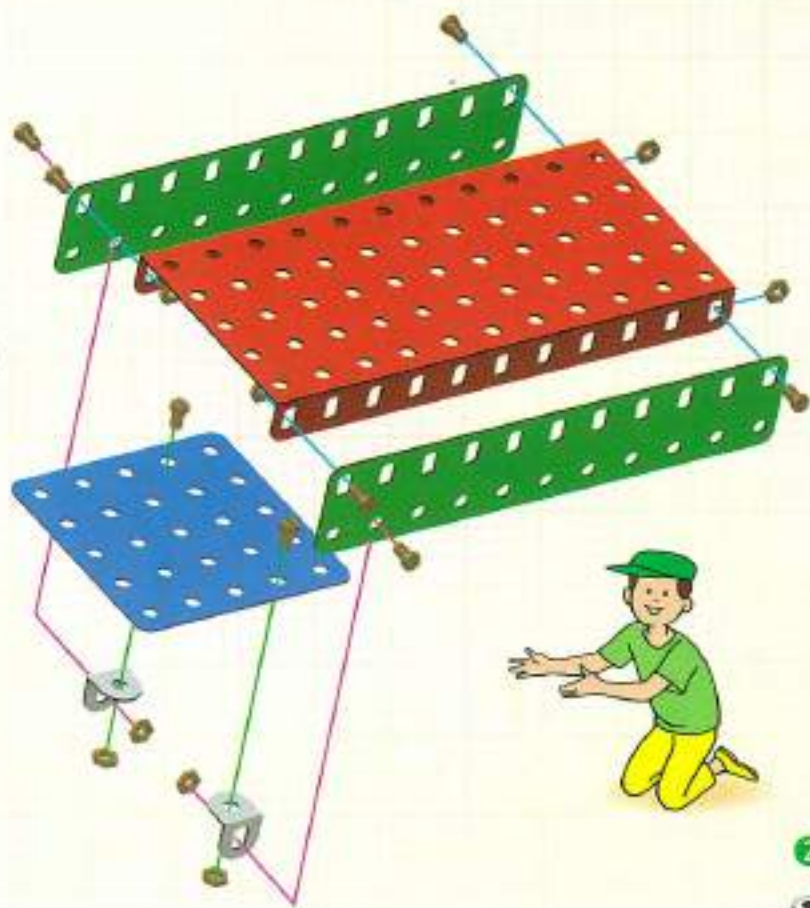

2



NUTS 9 pcs.



BOLTS 9 pcs.



AB-2 10 pcs.



A25-3 1 pc.



AB-5 1 pc.

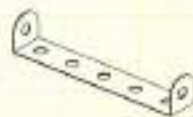

AB-7 1 pc.

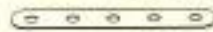

A-5 1 pc.

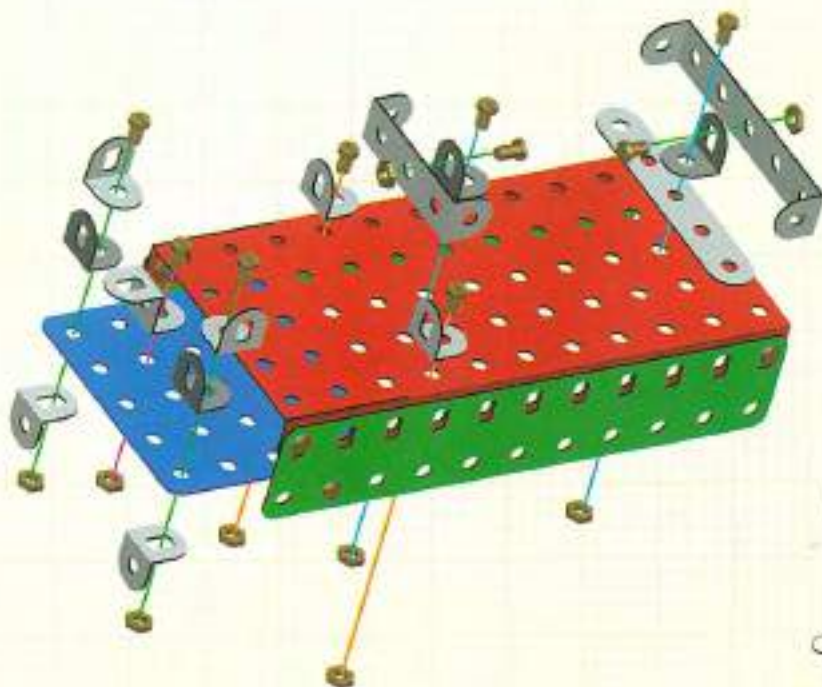

3



A-7 1 pc.



A8-7 2 pcs.



PY-1 2 pcs.



LONG BOLTS 2 pcs.



BOLTS 2 pcs.



NUTS 4 pcs.

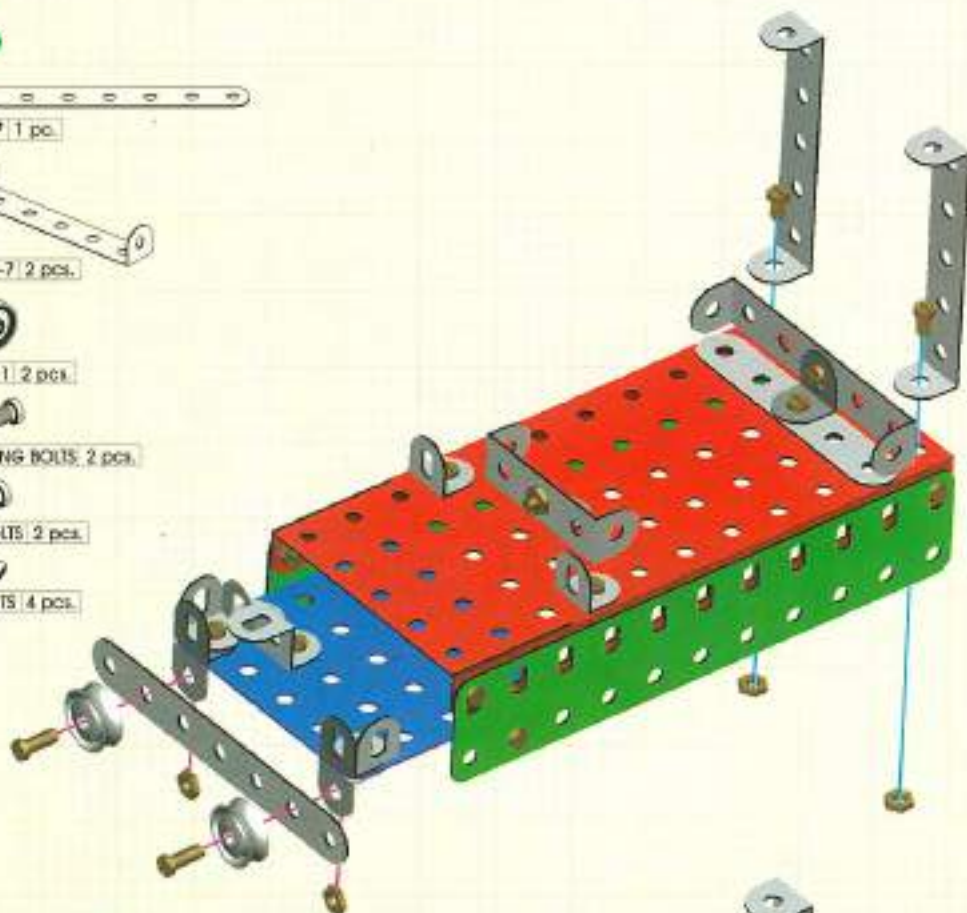

4



NUTS 6 pcs.



BOLTS 6 pcs.



U-CUP 2 pcs.



A8-2 1 pc.



SH-1 1 pc.



PY-2 1 pc.



BR-5 1 pc.



PSR-12 1 pc.



SG-25 1 pc.

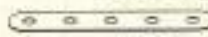

A-5 1 pc.

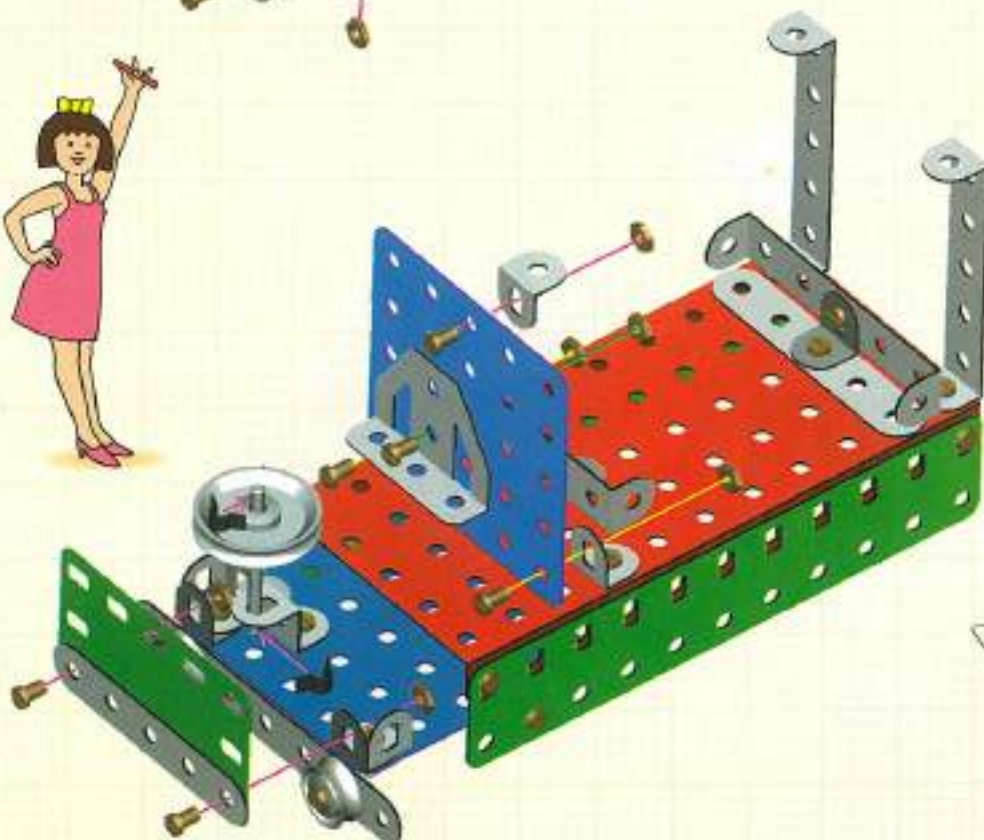

5

BH-4 3 pcs.



TH-26 1 pc.



WHEELS 6 pcs.



TW-1 6 pcs.



BOLTS 3 pcs.



NUTS 3 pcs.

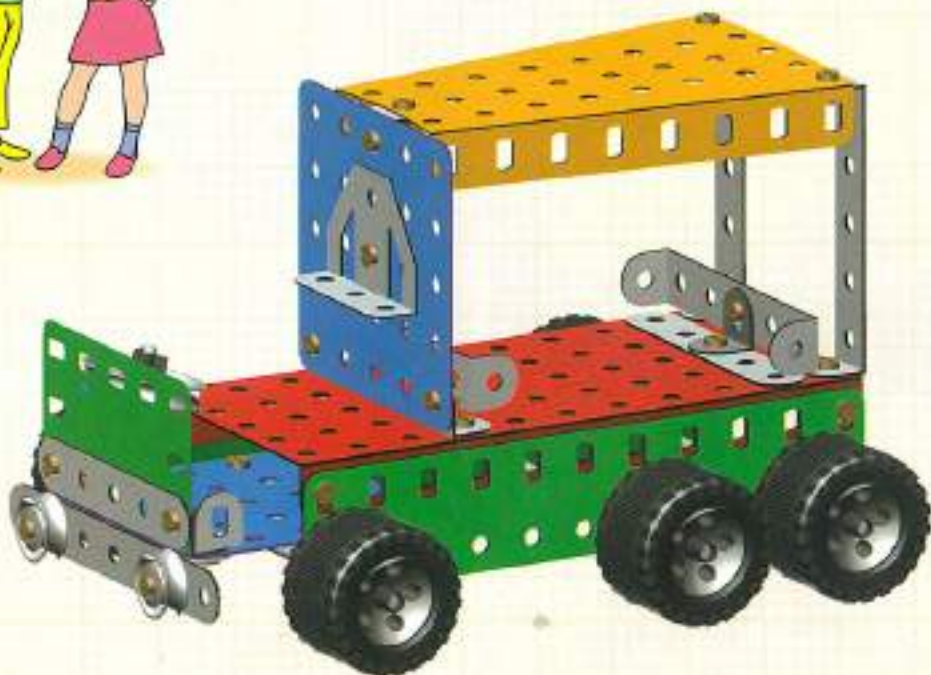
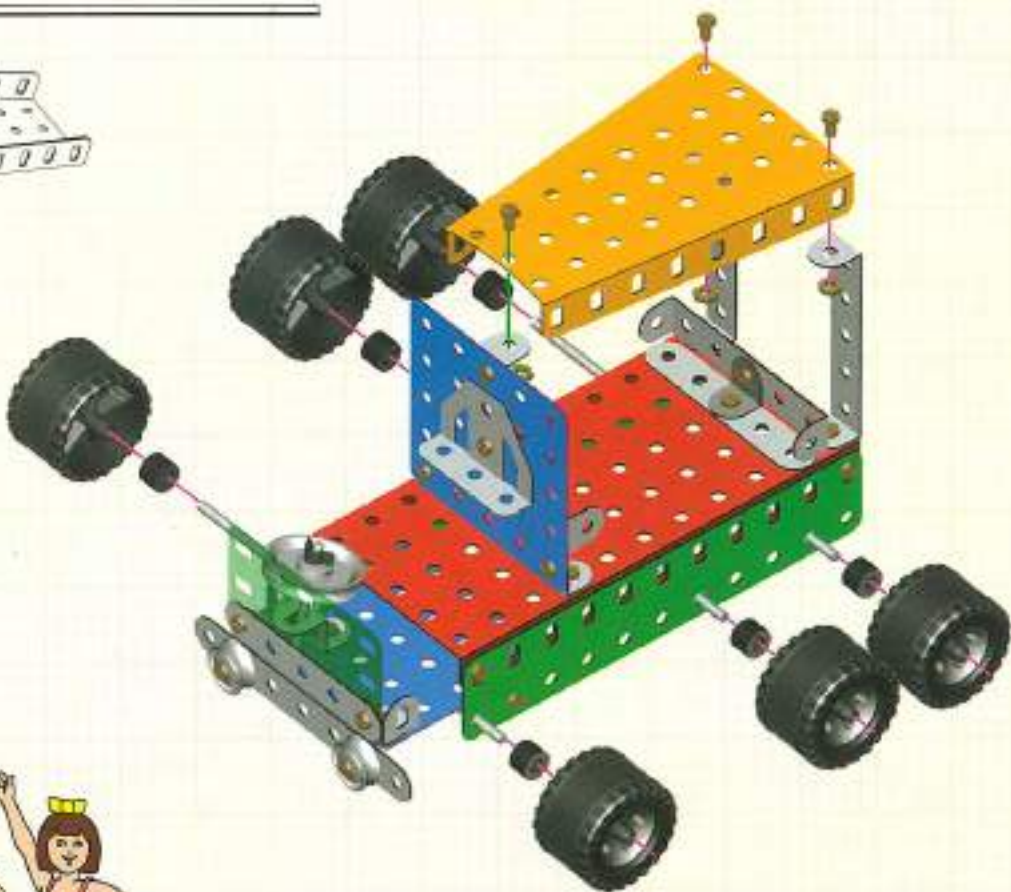



1

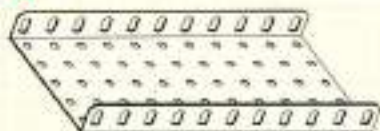

RT-65 | 1 pc.

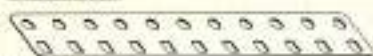

BLR-11 | 2 pcs.



SQ-25 | 1 pc.



V-8 | 2 pcs.



AB-2 | 4 pcs.



NUTS | 16 pcs.



BOILTS | 16 pcs.

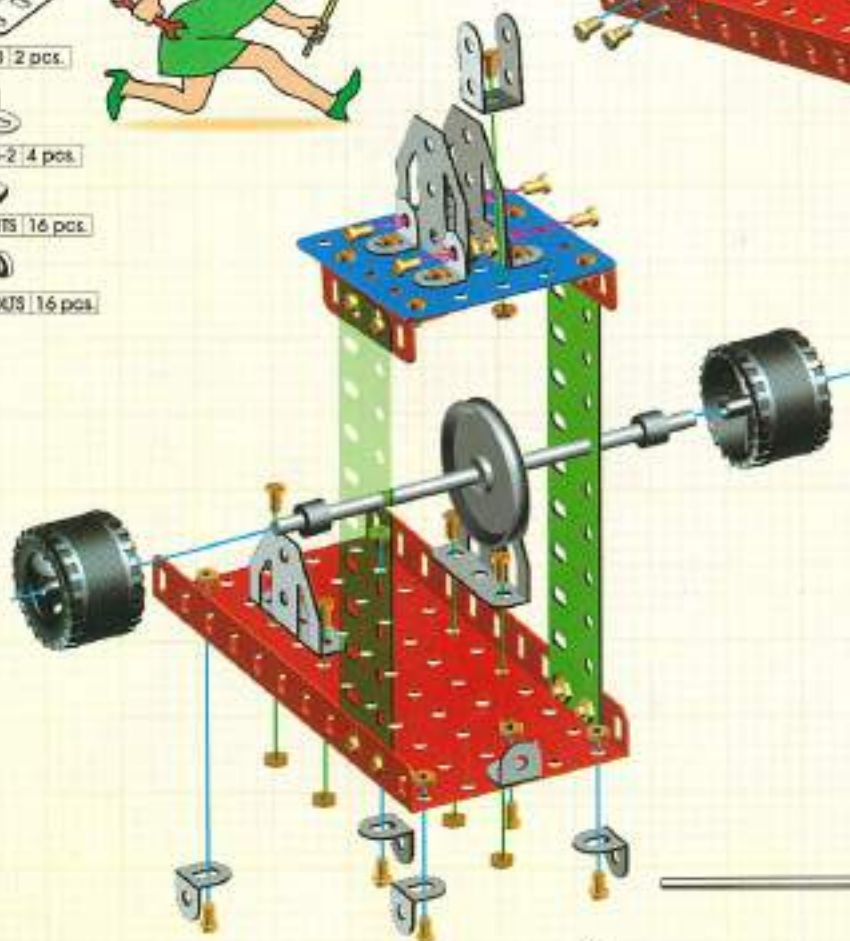

2

NUTS | 14 pcs.

BOILTS | 15 pcs.

TV-1 | 2 pcs.

AB-2 | 5 pcs.

ALB-5 | 1 pc.

BT-5 | 2 pcs.

BTB-5 | 2 pcs.

Pr-3 | 1 pc.

WHEELS | 2 pcs.

SH-4 | 1 pc.

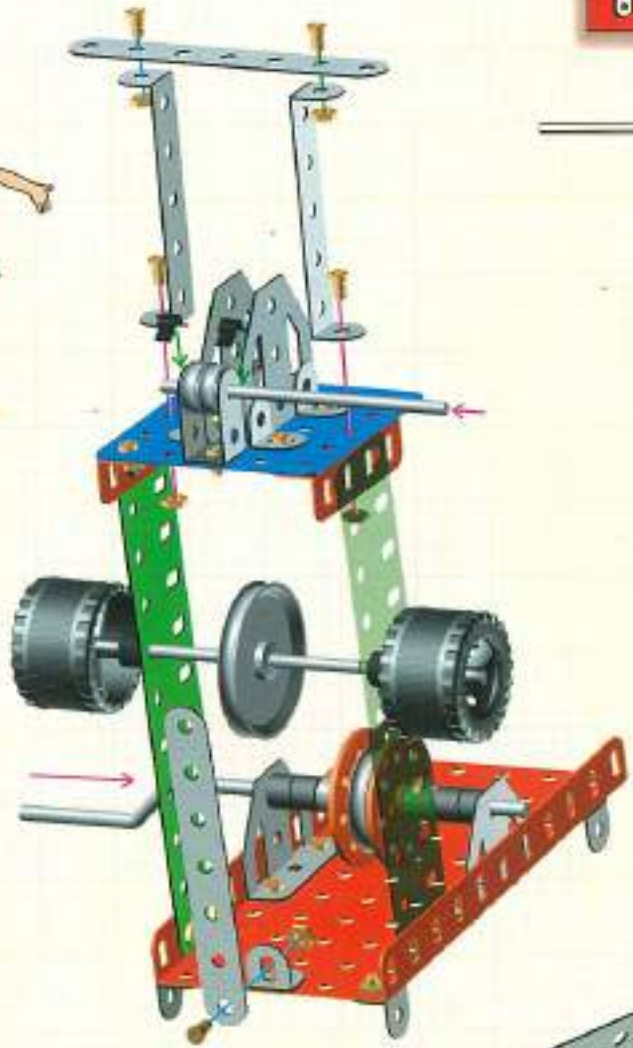

3

- BENT SHAFT | 1 pc.
- SH-2 | 1 pc.
- A-7 | 2 pcs.
- R-8 | 2 pcs.
- AB-7 | 2 pcs.
- PY-1 | 2 pcs.
- PY-2 | 1 pc.
- TW-1 | 4 pcs.
- U-CLIP | 2 pcs.
- NUTS | 5 pcs.
- BOLTS | 7 pcs.

4

- NUTS | 10 pcs.
- BOLTS | 10 pcs.
- TW-1 | 2 pcs.
- U-CLIP | 2 pcs.
- H-1 | 1 pc.
- SH-1 | 1 pc.
- A-5 | 8 pcs.
- A-11 | 4 pcs.

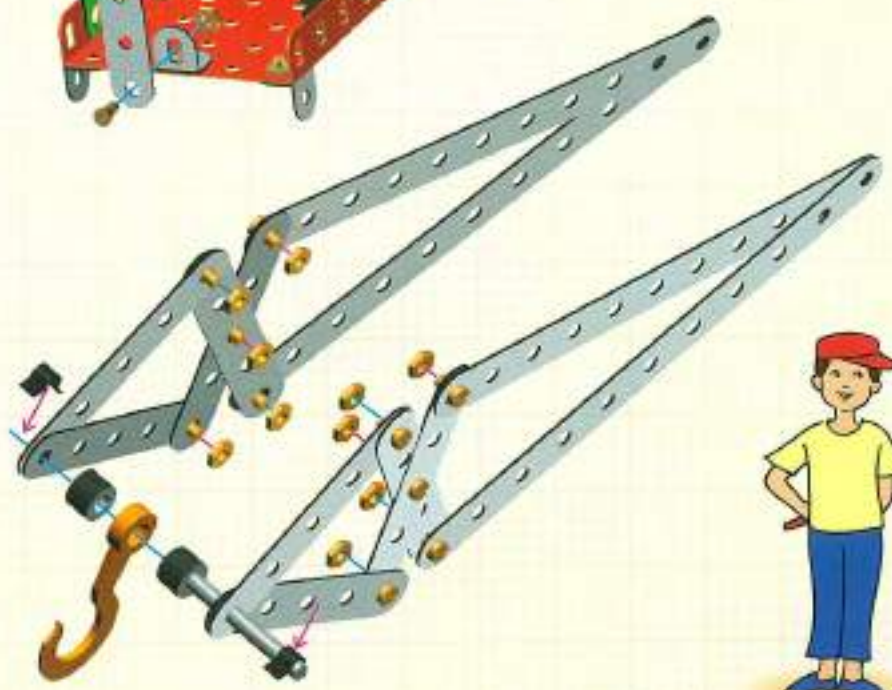

In this step, tighten all the bolts and nuts with hands. Do not over tighten them otherwise it will hinder the front back movement.

5

SH-4 2 pcs.

SH-1 1 pc.

TW-1 4 pcs.

PY-2 1 pc.

WHEELS 4 pcs.

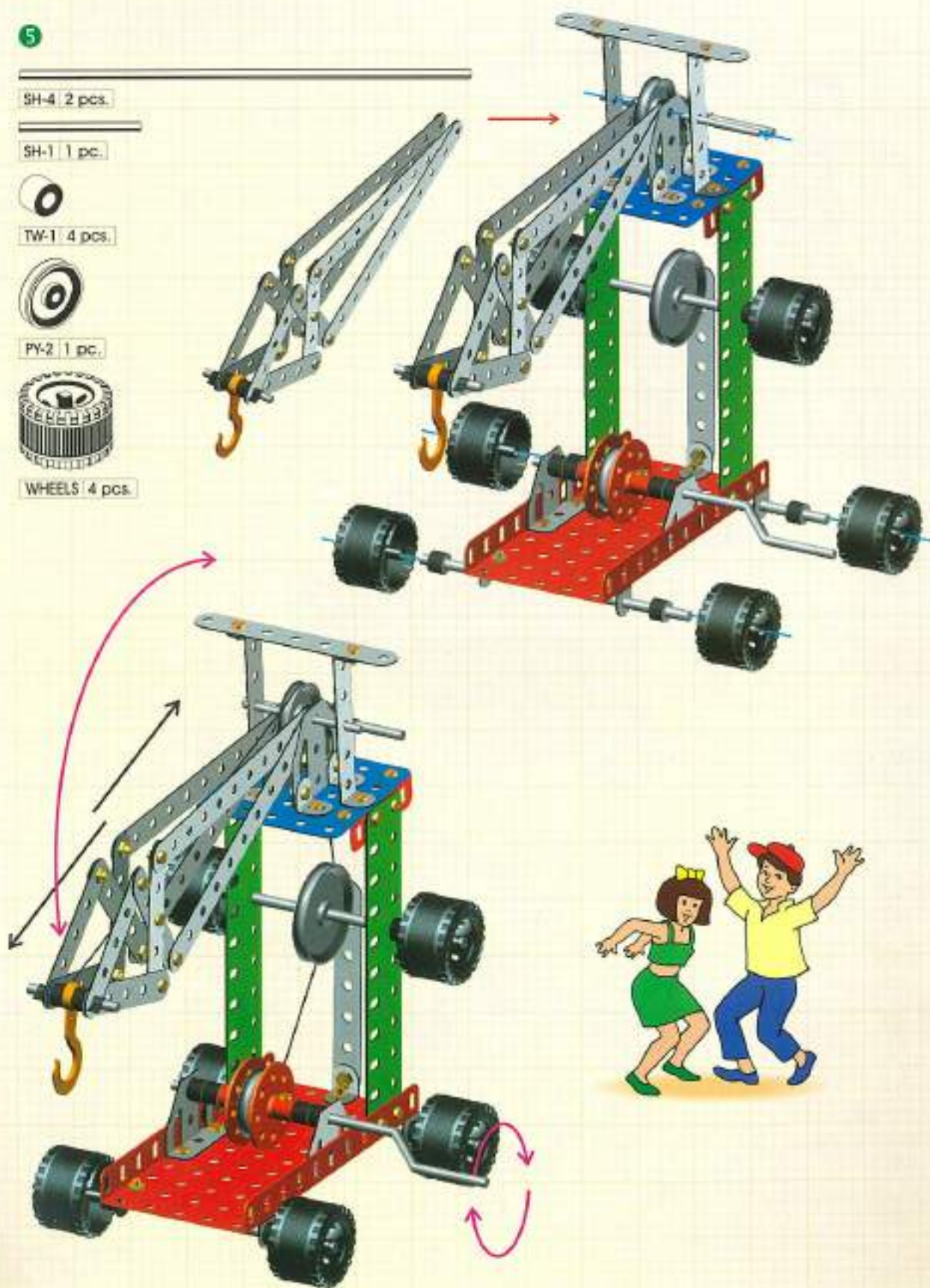



1

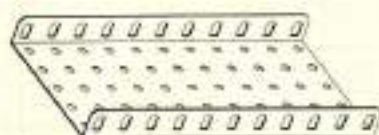

RT-55 1 pc.



AB-7 2 pcs.



A-4 2 pcs.



AB-2 2 pcs.

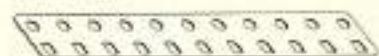

BLR-11 2 pcs.



NUTS 8 pcs.



BOLTS 8 pcs.

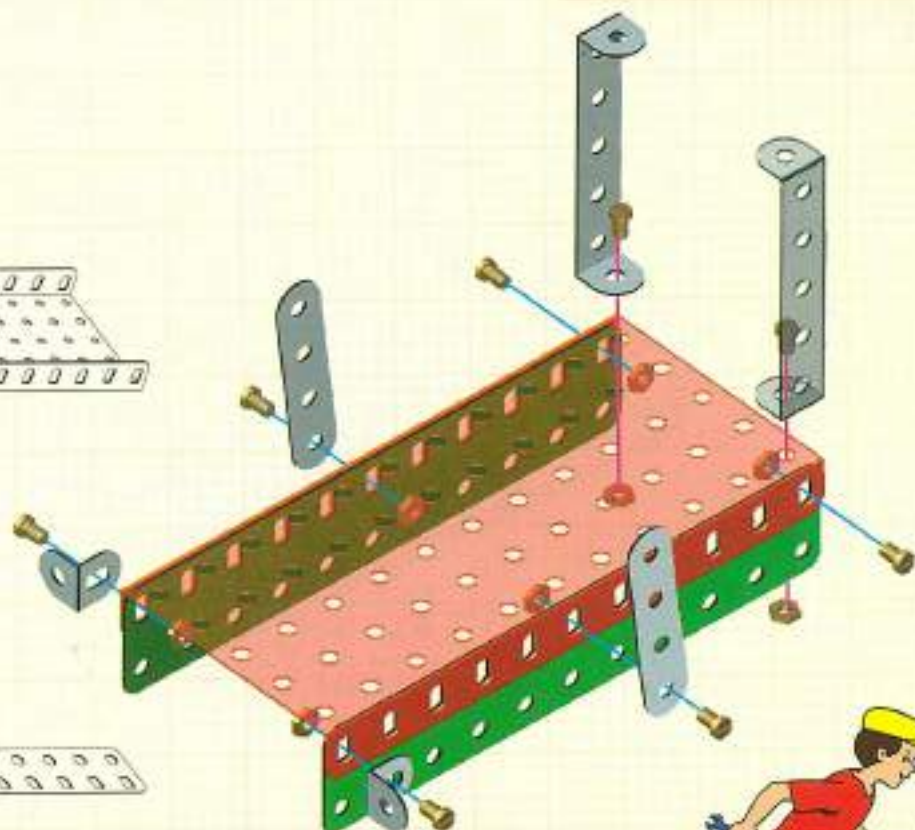

2



NUTS 10 pcs.



BOLTS 10 pcs.



AB-2 4 pcs.

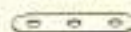

A-3 2 pcs.



BTB-5 2 pcs.

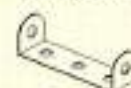

AB-5 2 pcs.

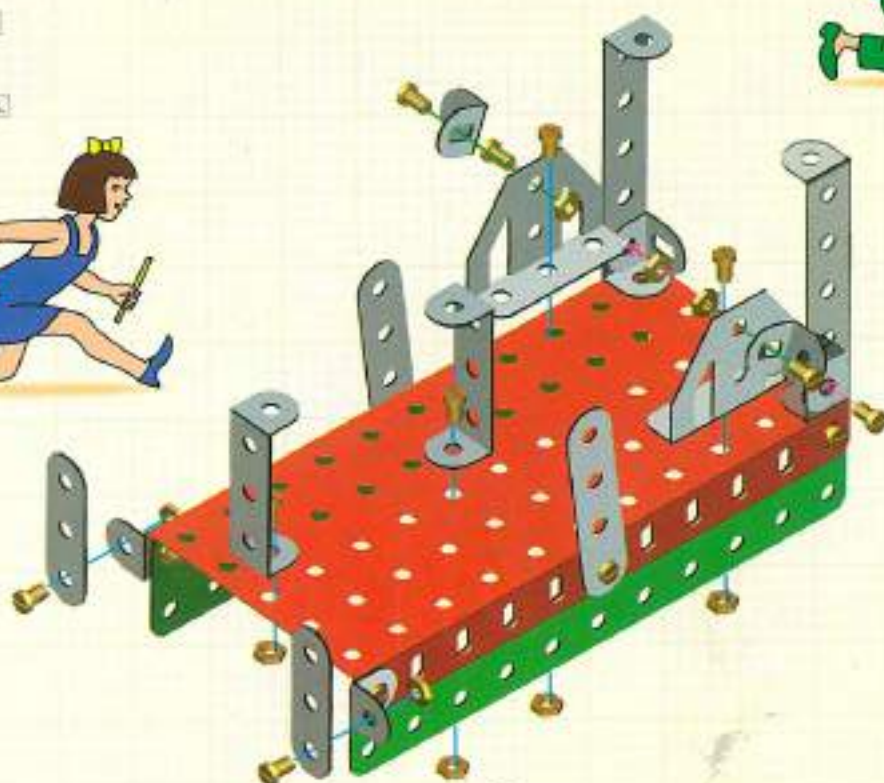

3



V-8 2 pcs.



R-8 1 pc.



PY-3 1 pc.

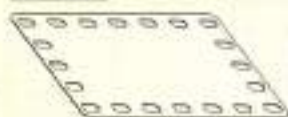

PLR-20 2 pcs.



BENT SHAFT 1 pc.



NUTS 4 pcs.



BOLTS 6 pcs.

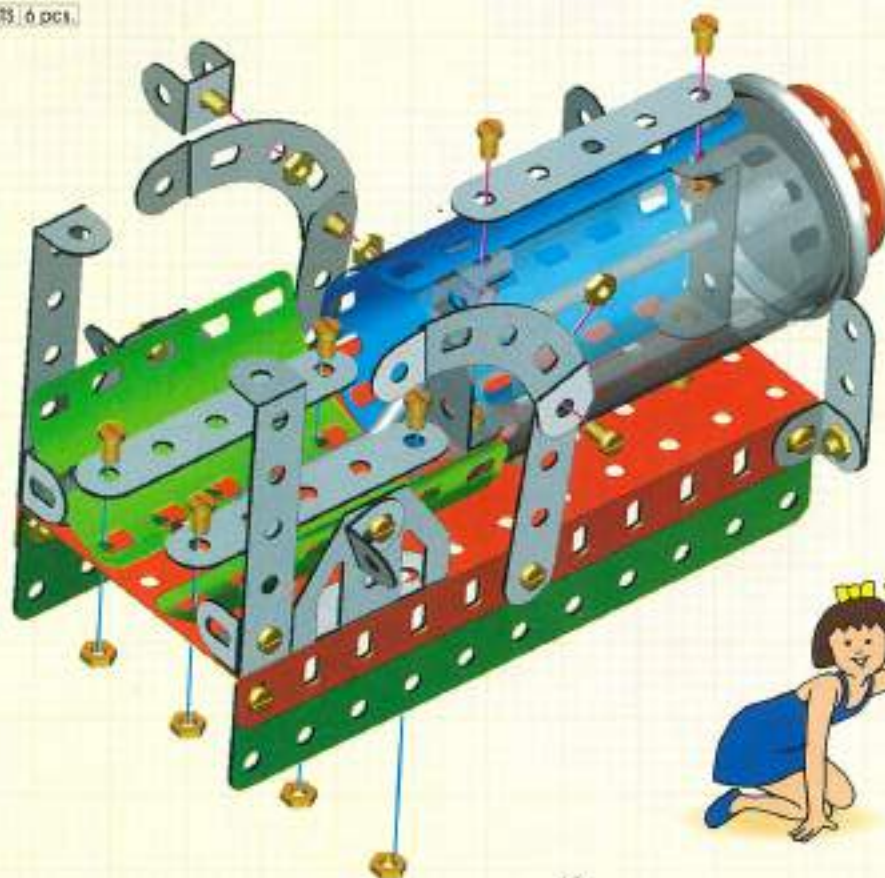
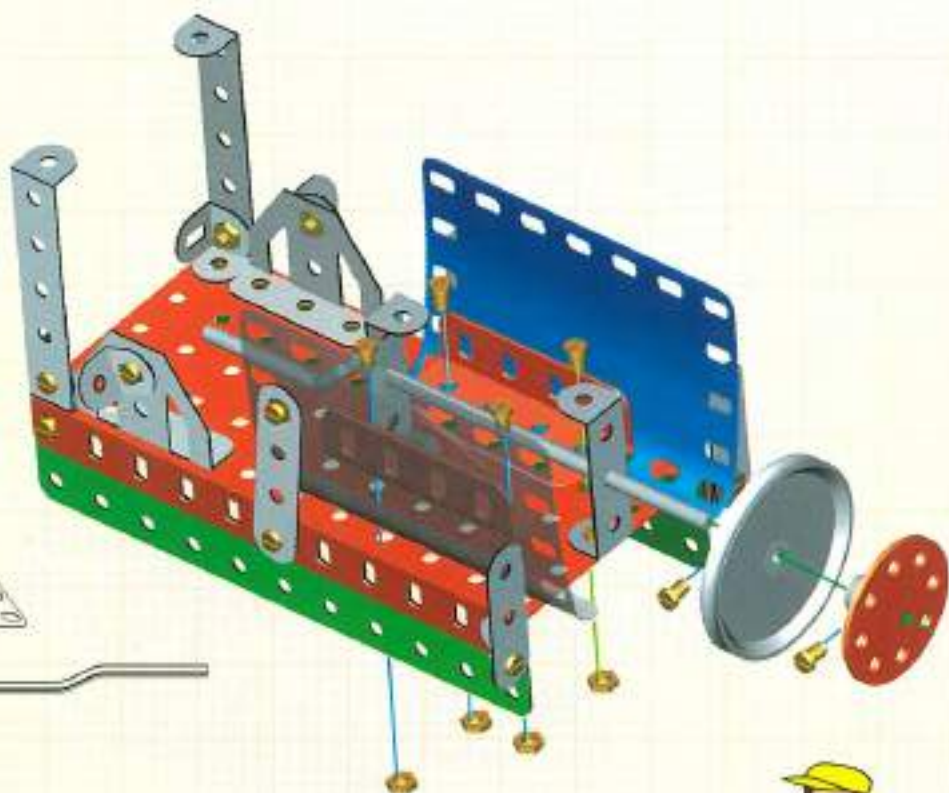

4



NUTS 9 pcs.



BOLTS 9 pcs.



AB-3 1 pc.



HS-5 2 pcs.



PSR-12 2 pcs.

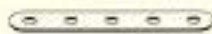

A-5 3 pcs.

5

SH-4 2 pcs.

SH-2 1 pc. SH-1 2 pcs.

A-5 1 pc.

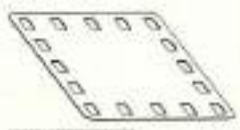

PSQ-16 1 pc.



PY-2 2 pcs.



I-1 1 pc.



R-6 1 pc.



ALB-5 1 pc.



U-CUP 4 pcs.



H-1 1 pc.



NUTS 3 pcs.



BOLTS 4 pcs.

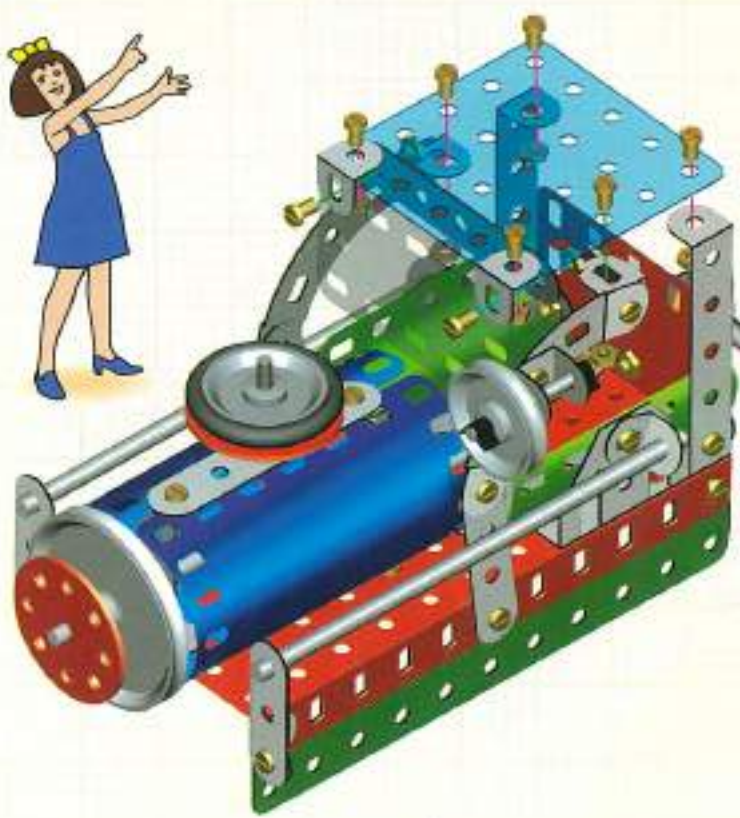
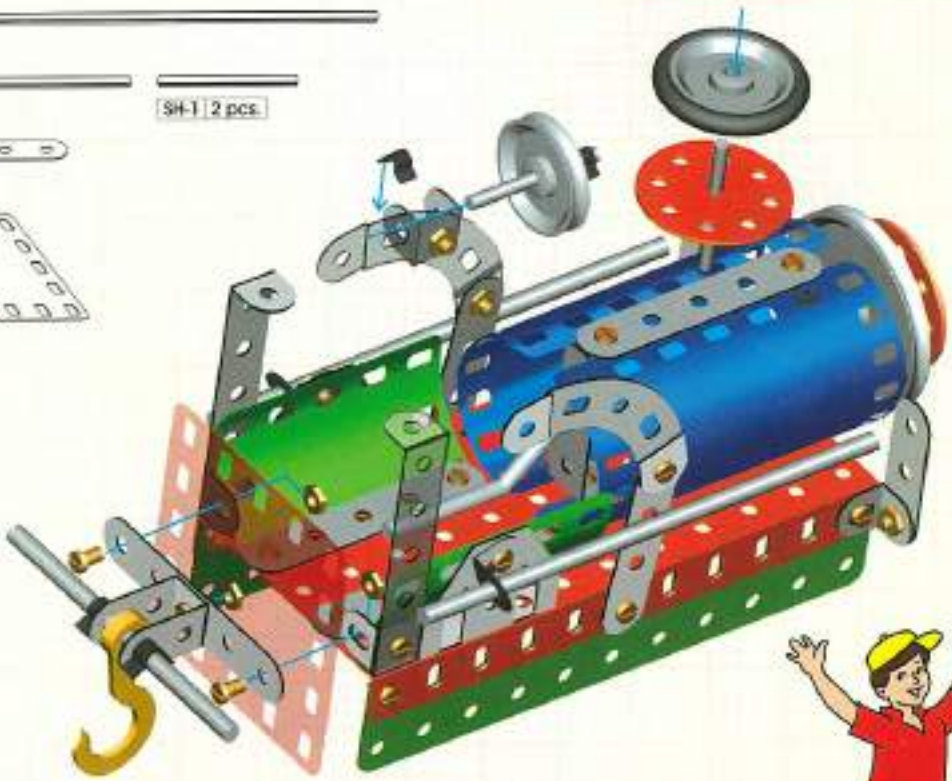

6

NUTS 8 pcs.

BOLTS 8 pcs.

AB-2 4 pcs.

A-5 1 pc.

PSR-12 (transparent) 1 pc.

SQ-25 1 pc.

7



TW-1 6 pcs.



U-CLIP 4 pcs.

SH-3 2 pcs.

SH-4 1 pc.



WHEELS 6 pcs.

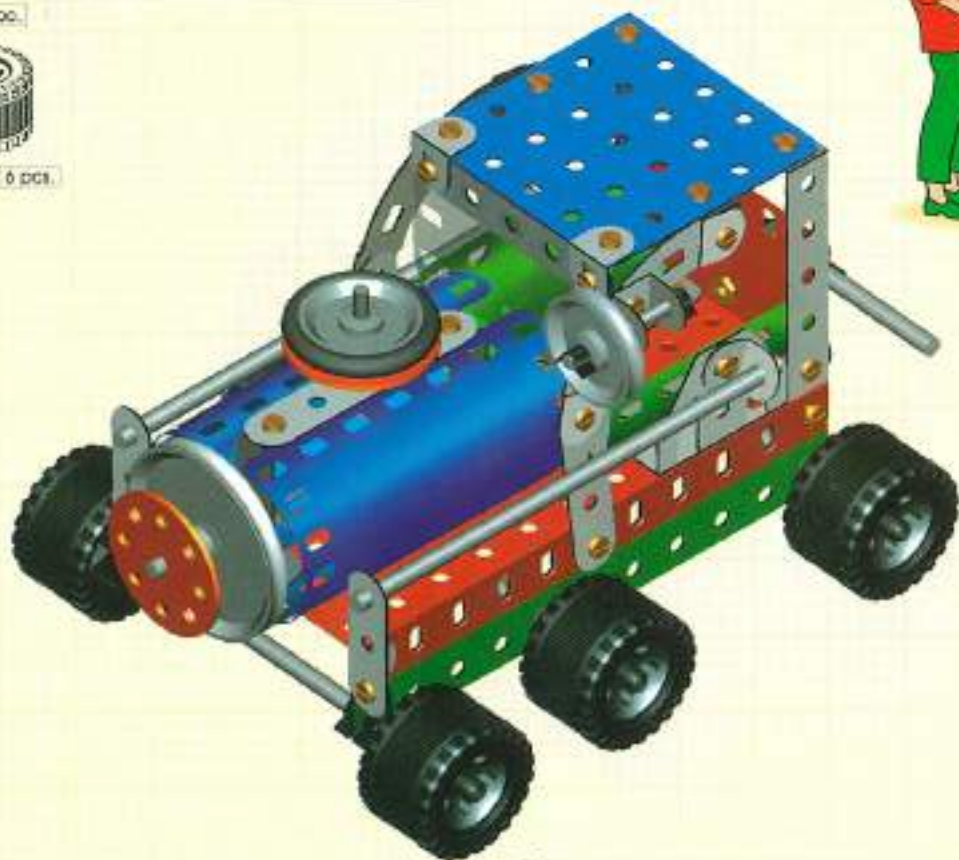
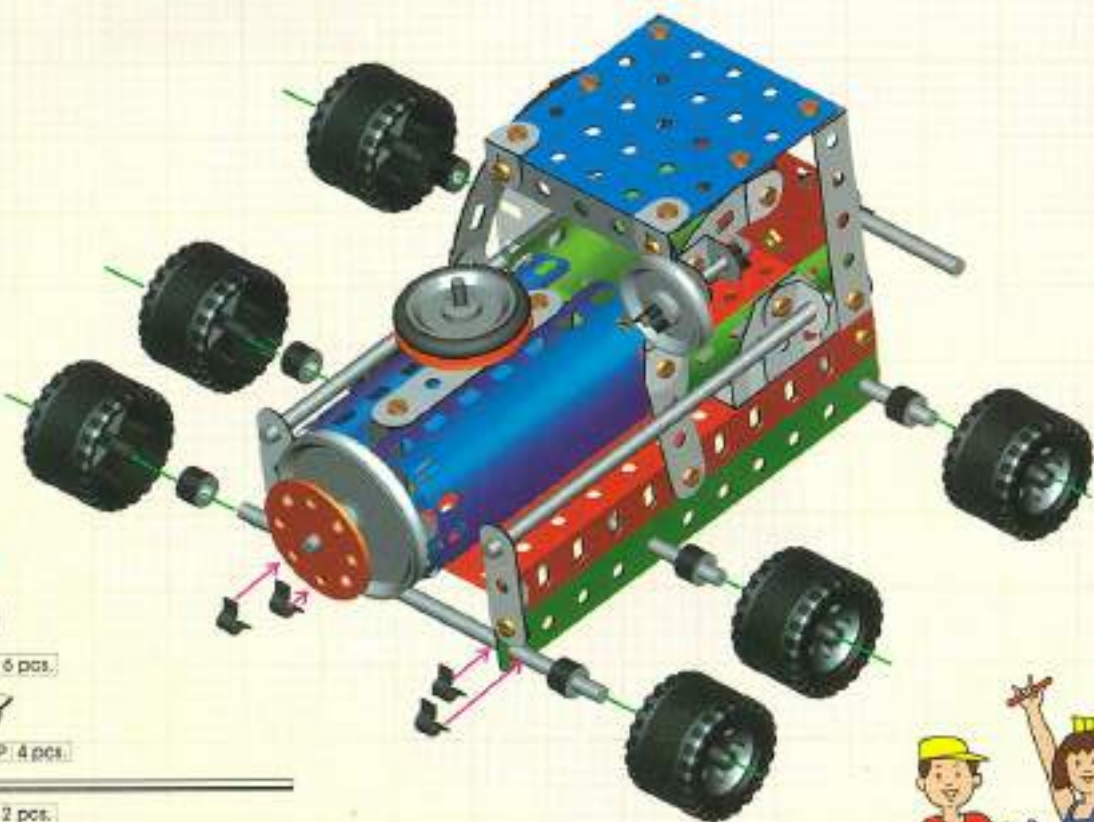

1

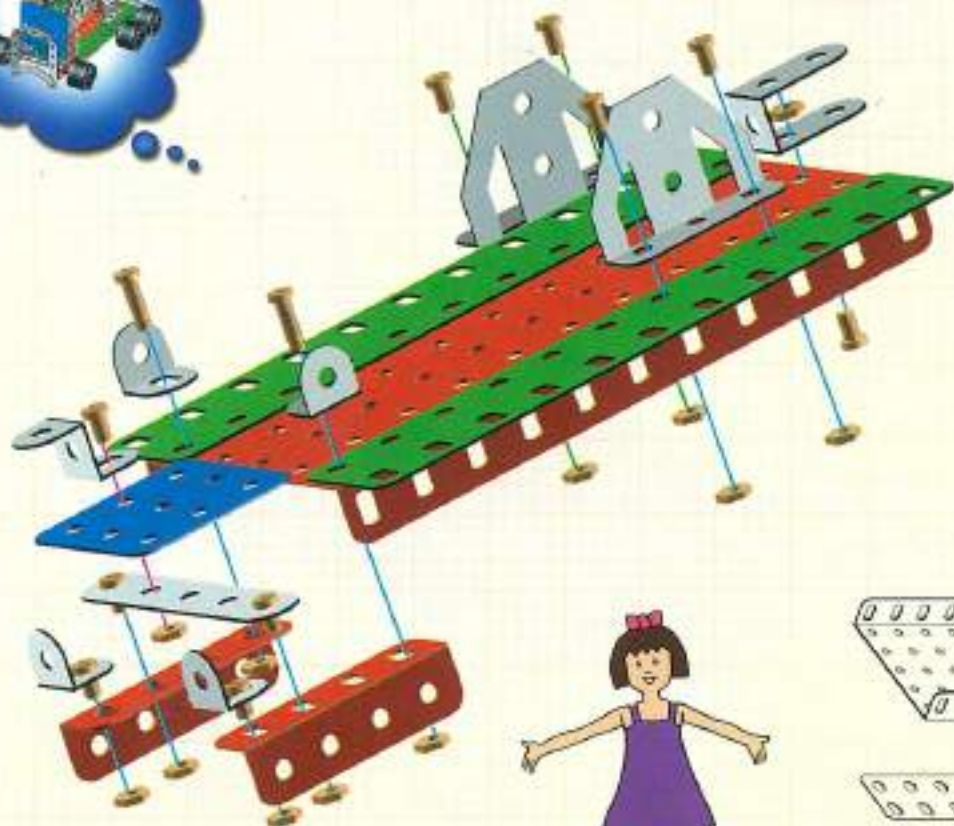

A-5 | 1 pc.



92-9 | 1 pc.



BT-5 | 2 pcs.



AB-2 | 4 pcs.



AZS-3 | 1 pc.



ALB-5 | 1 pc.



V-8 | 2 pcs.



RT-55 | 1 pc.

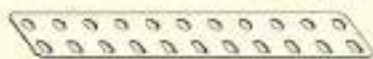

BUR-11 | 2 pcs.



LONG BOLTS | 2 pcs.



BOLTS | 10 pcs.



NUTS | 12 pcs.

2



NUTS | 10 pcs.



BOLTS | 10 pcs.



AB-2 | 2 pcs.



BT-5 | 2 pcs.

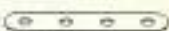

A-4 | 4 pcs.



AB-7 | 1 pc.

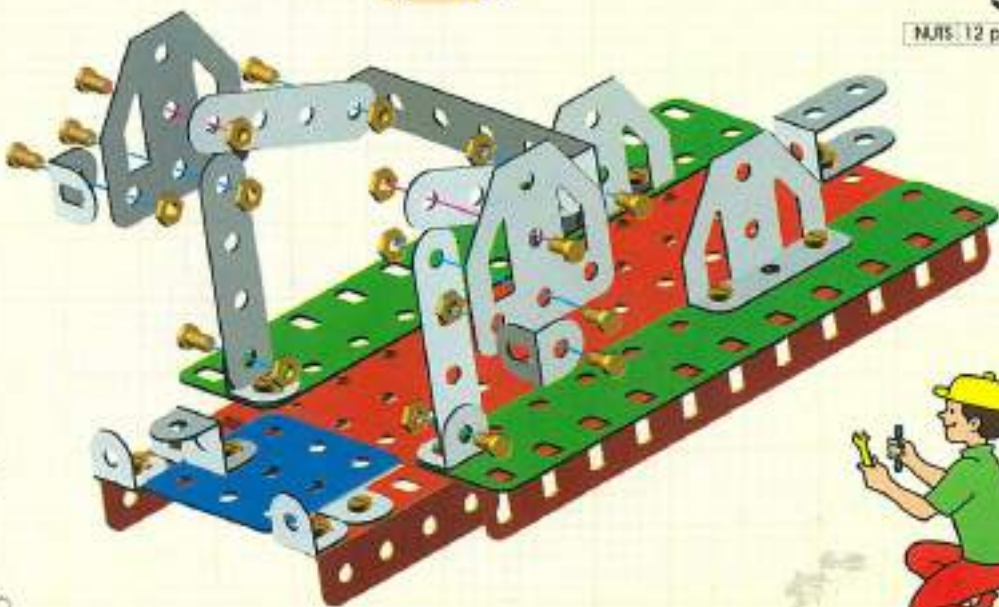

3

BENT SHAFT 1 pc.

SH-3 1 pc.

A-11 2 pcs.

A-7 2 pcs.



R-B 2 pcs.



U-CLIP 4 pcs.



NUTS 2 pcs.



BOLTS 4 pcs.

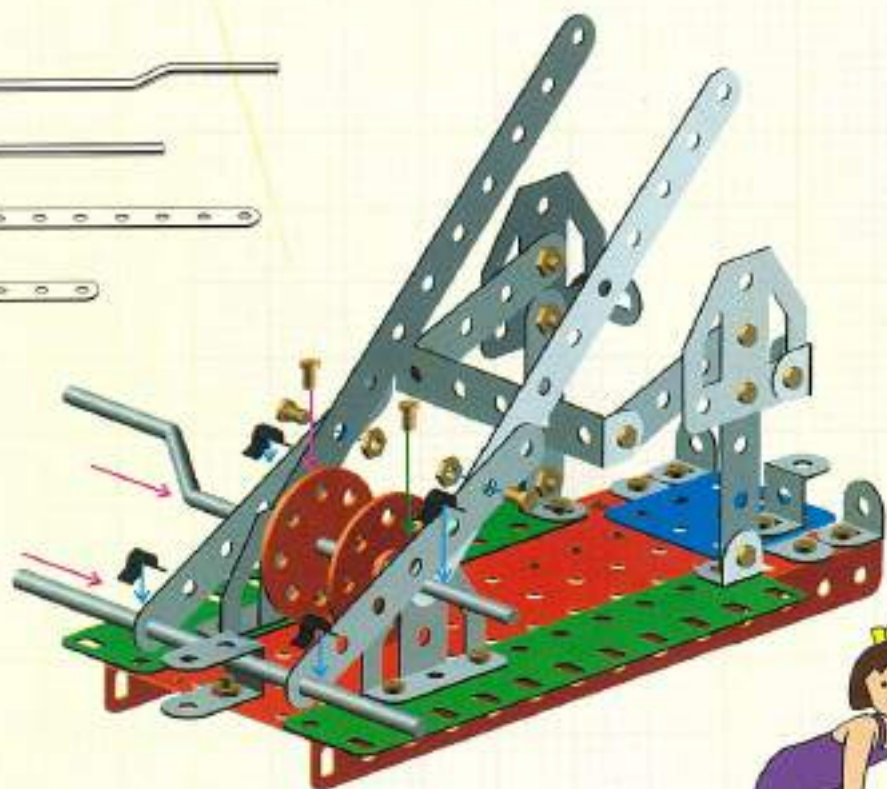

4

NUTS 4 pcs.

BOLTS 4 pcs.

U-CLIP 2 pcs.

PV-1 2 pcs.

A-2 4 pcs.

AB-3 2 pcs.

B-PY-2 1 pc.

AB-5 1 pc.

SH-2 1 pc.

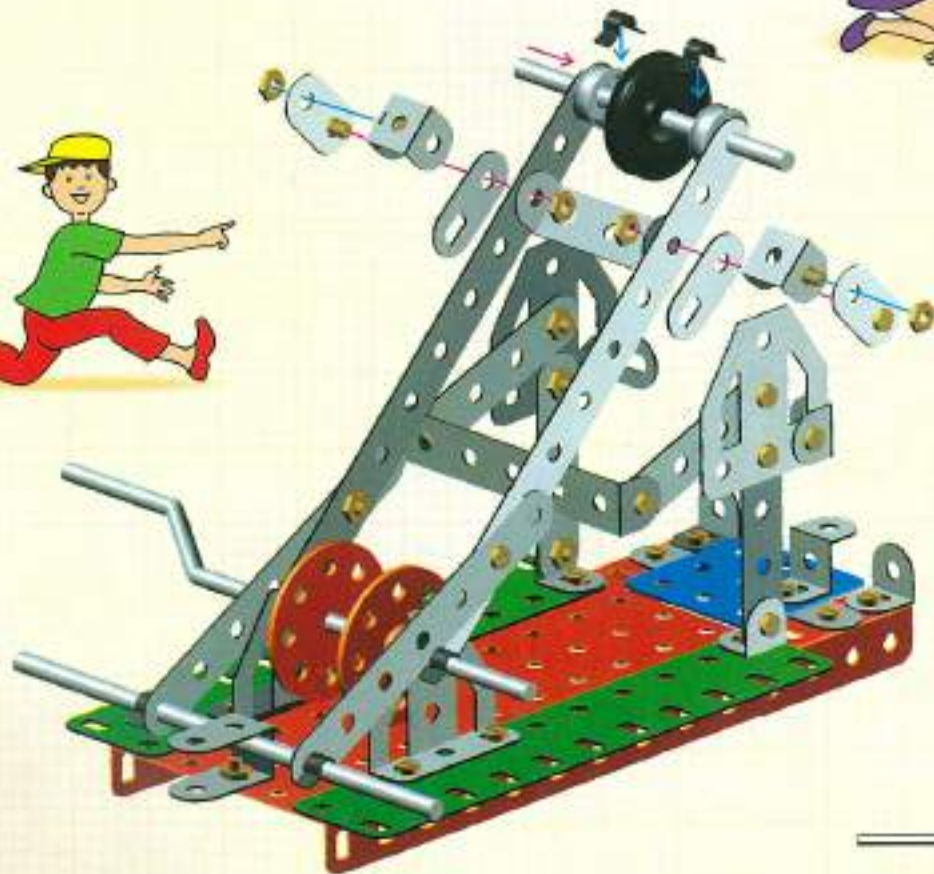

5



A-11 | 2 pcs.



A-3 | 2 pcs.



SH-1 | 1 pc.



AB-2 | 4 pcs.



AUB-5 | 1 pc.

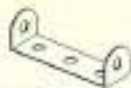

AB-5 | 1 pc.



PK-3 | 1 pc.



THREAD | 1 pc.



NUTS | 10 pcs.



BOLTS | 11 pcs.

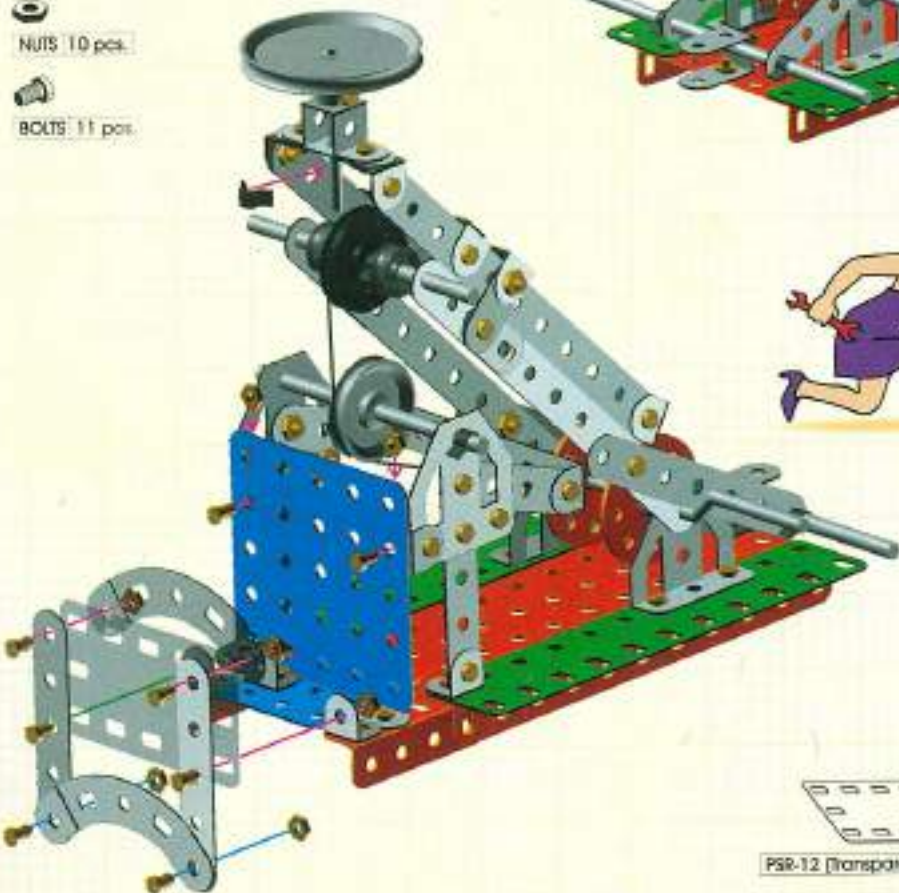
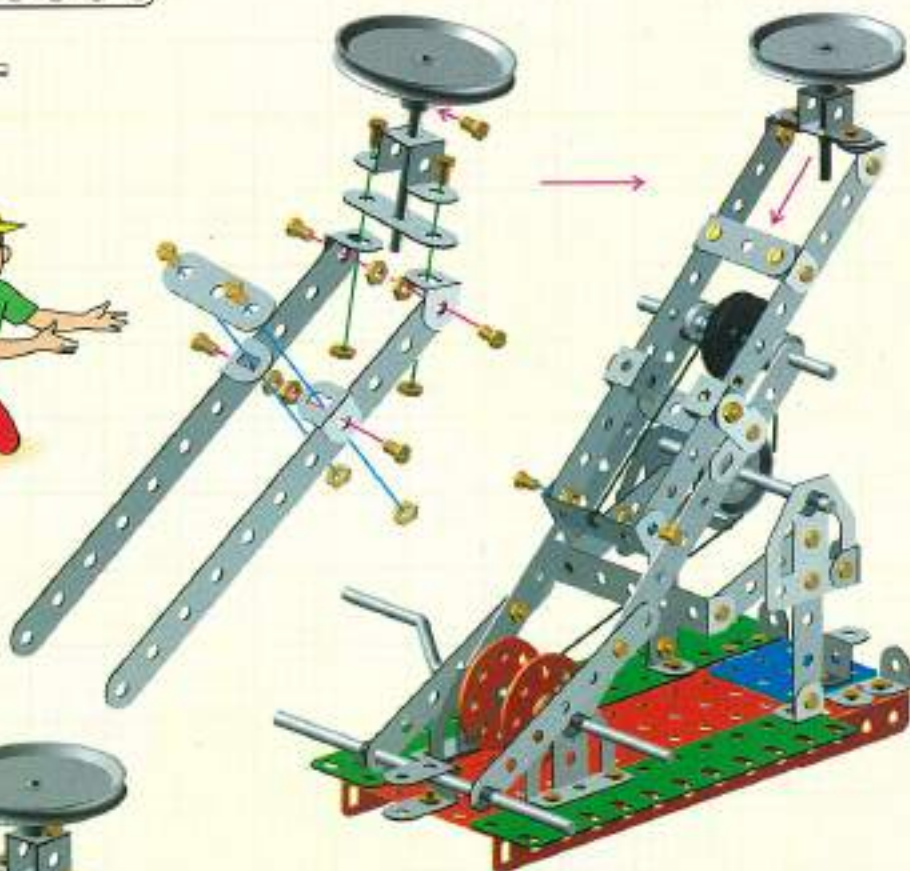

6



NUTS | 8 pcs.



BOLTS | 8 pcs.



U-CLIP | 1 pc.



HS-5 | 2 pcs.

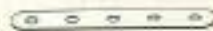

A-5 | 2 pcs.

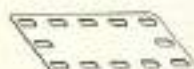

PSR-12 (transparent) | 1 pc.



SQ-25 | 1 pc.

7

SH-4 3 pcs.



WHEELS 6 pcs.



TW-1 10 pcs.

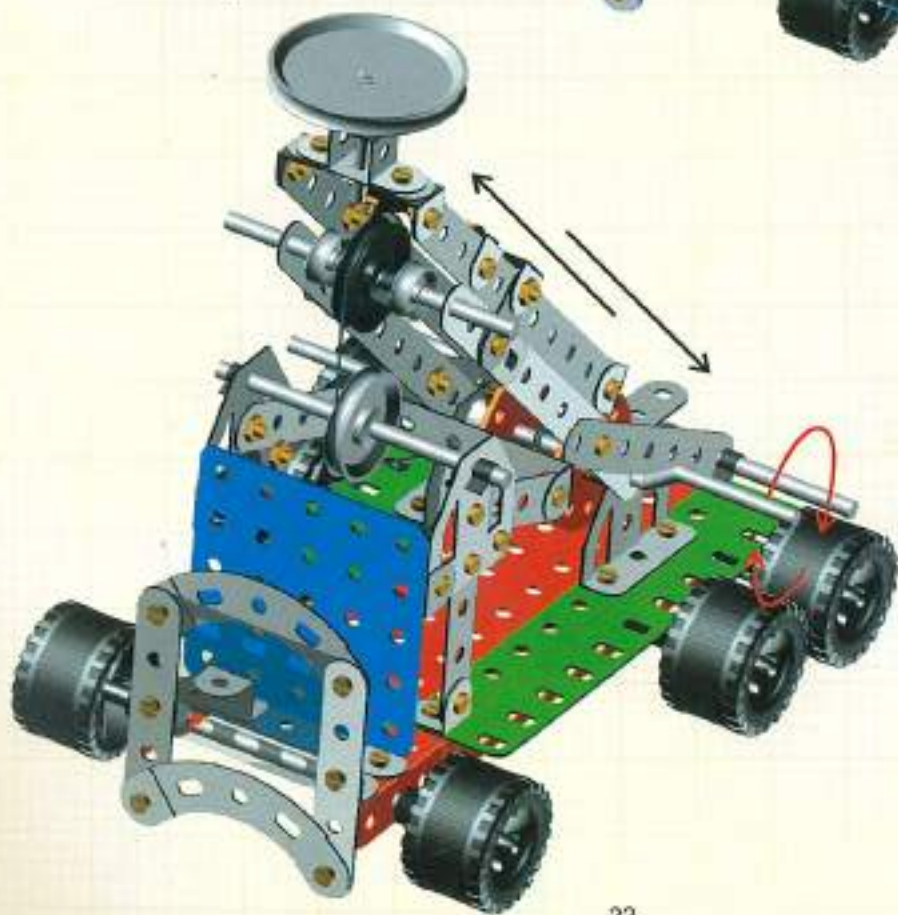
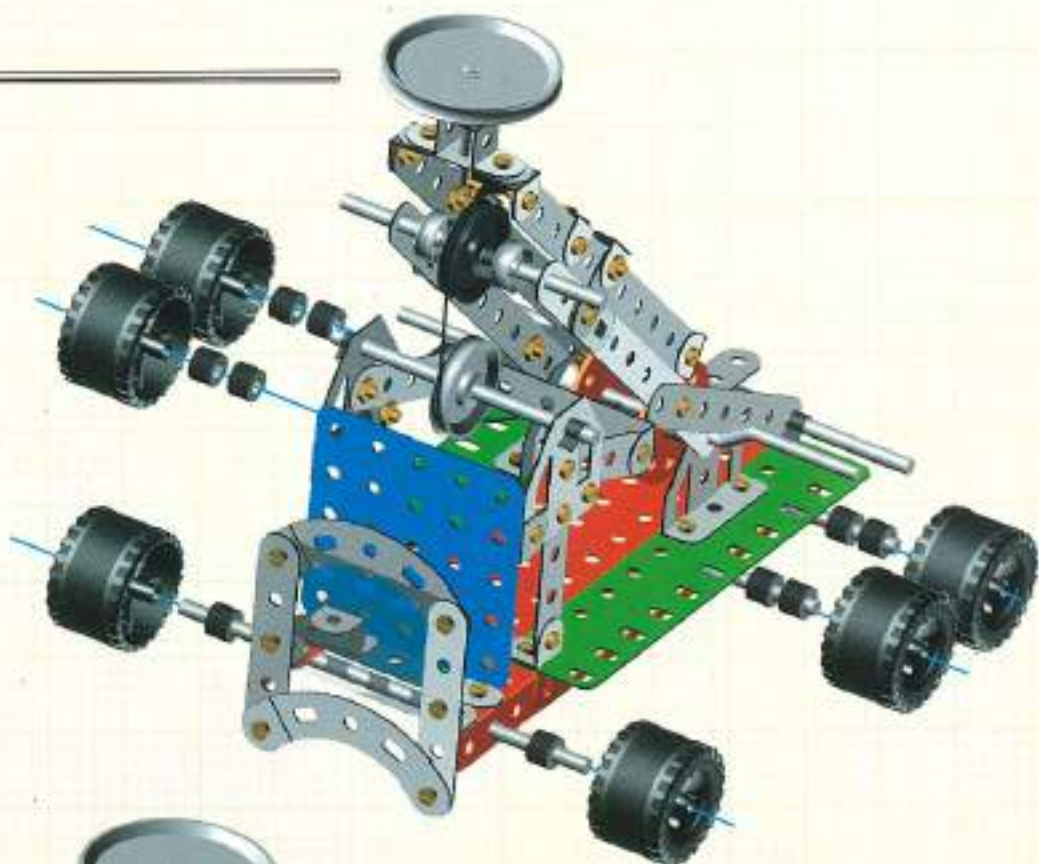

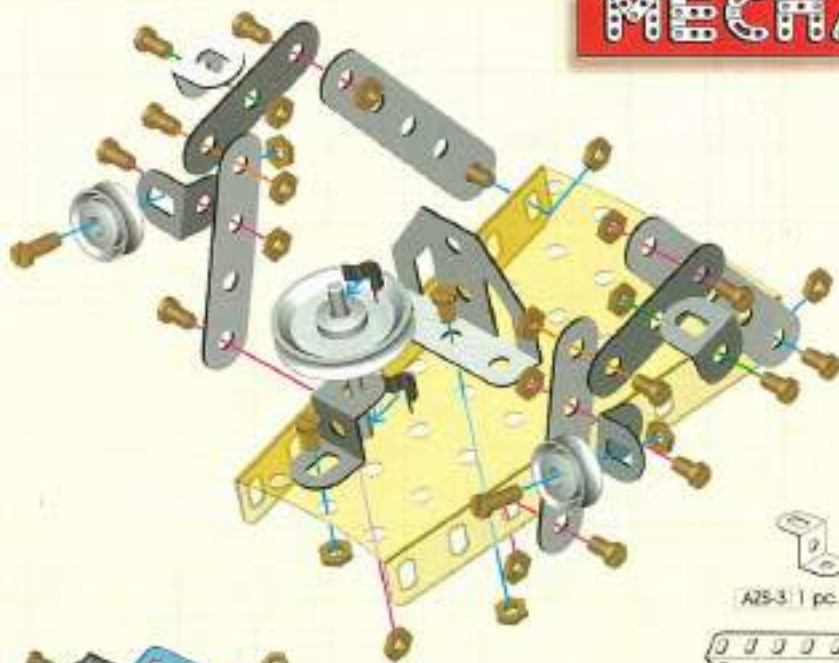

- 1**
-  NUTS 16 pcs.
-  BOLTS 16 pcs.
-  PY-1 2 pcs.
-  U-CLIP 2 pcs.
-  A2S-3 1 pc.
-  AB-2 4 pcs.

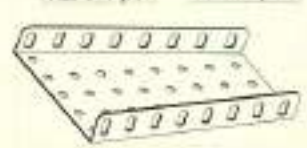

TB-26 1 pc.



PY-2 1 pc.



BTB-5 1 pc.

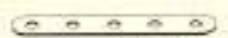

A-5 2 pcs.

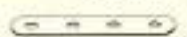

A-4 2 pcs.

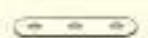

A-3 2 pcs.



SH-1 1 pc.

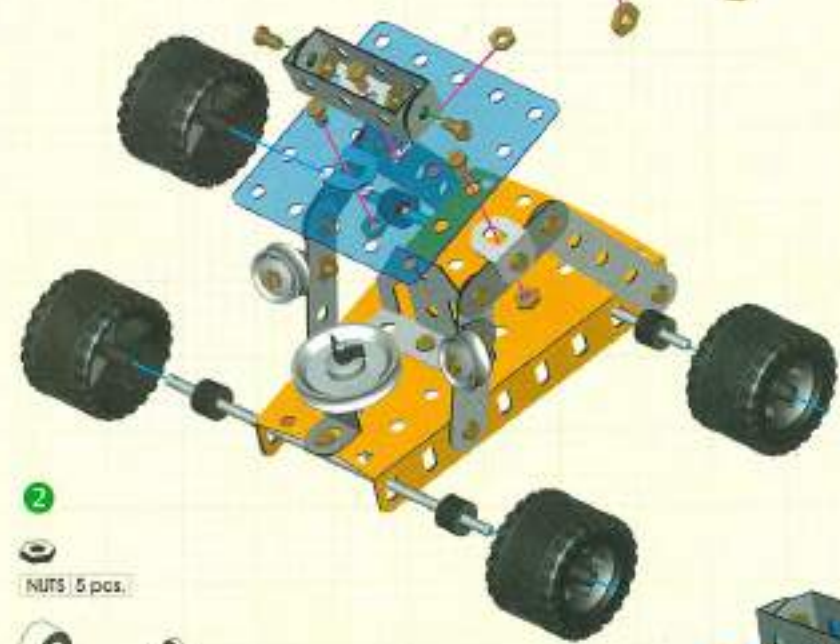

- 2**
-  NUTS 5 pcs.
-  PY-1 4 pcs.
-  BOLTS 5 pcs.
-  WHEELS 4 pcs.
-  AB-5 3 pcs.
-  SQ-25 1 pc.
-  SH-4 2 pcs.

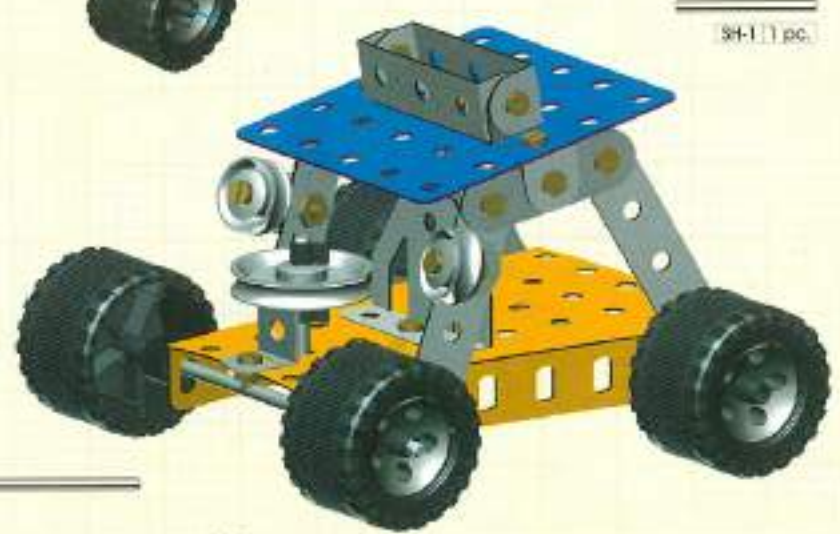



A-6 | 1 pc.



AUB-3 | 1 pc.



AB-2 | 4 pcs.



HS-5 | 2 pcs.



AB-7 | 2 pcs.



SQ-25 | 1 pc.

SH-1 | 1 pc.



R-6 | 1 pc.



BTB-5 | 1 pc.



BT-5 | 2 pcs.

BOLTS | 17 pcs.

NUTS | 16 pcs.

ROBOT

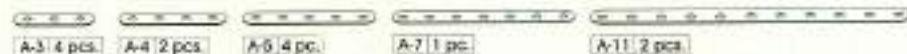

NUTS | 26 pcs. BOLTS | 28 pcs. LONG BOLTS | 2 pcs. PY-1 | 2 pcs. AB-2 | 7 pcs. AB-3 | 3 pcs.

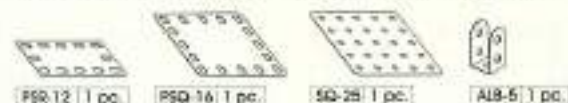

PRAM

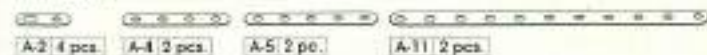

SH-4 | 1 pc.

AB-2 | 6 pcs. TW-1 | 2 pcs. NUTS | 20 pcs. BOLTS | 20 pcs.



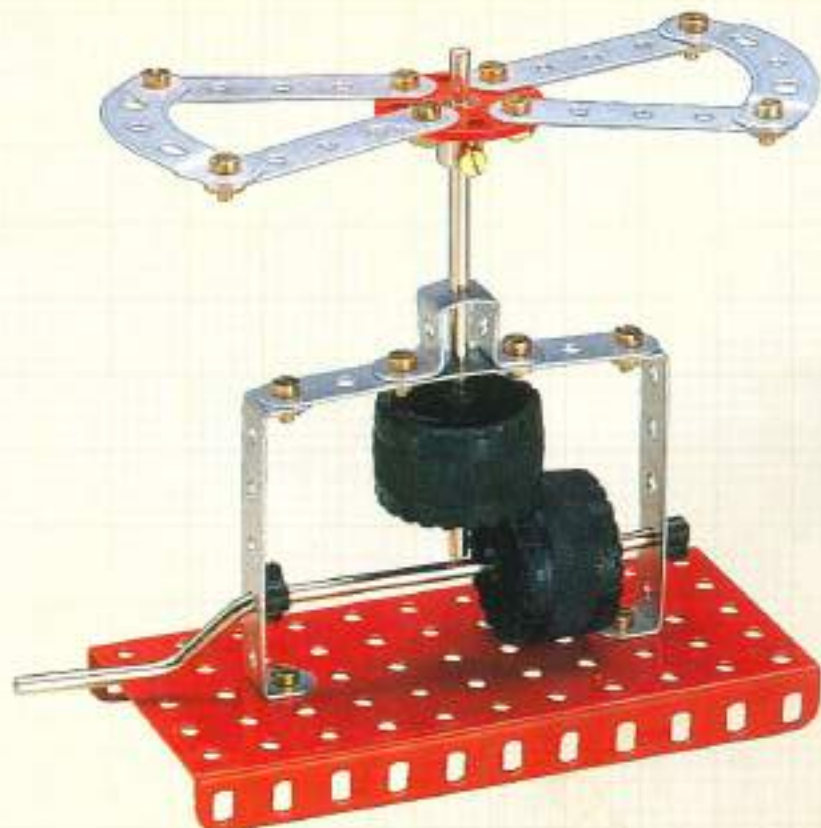
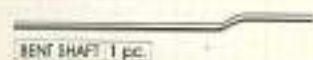
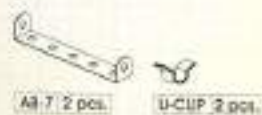
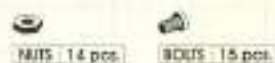
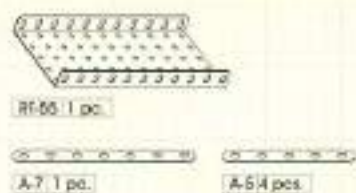
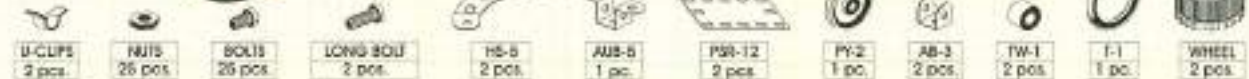

A-11 2 pcs. A-7 2 pcs. A-5 4 pcs.

A-6 2 pcs.

A-2 4 pcs.

A-3 2 pcs.

SH-3 1 pc.

SH-20 1 pc.

PSQ 16 1 pc.

PSR-12 3 pcs.

PSR-12 (transp.) 1 pc.

HS-5 2 pcs.

AB-7 9 pcs.

AB-2 4 pcs.

NUTS 30 pcs.

SOUS 32 pcs.

AB-3 1 pc.

ALR-5 1 pc.

BT-5 2 pcs.

TW-1 1 pc.

O-3 1 pc.

WHEEL 2 pcs.

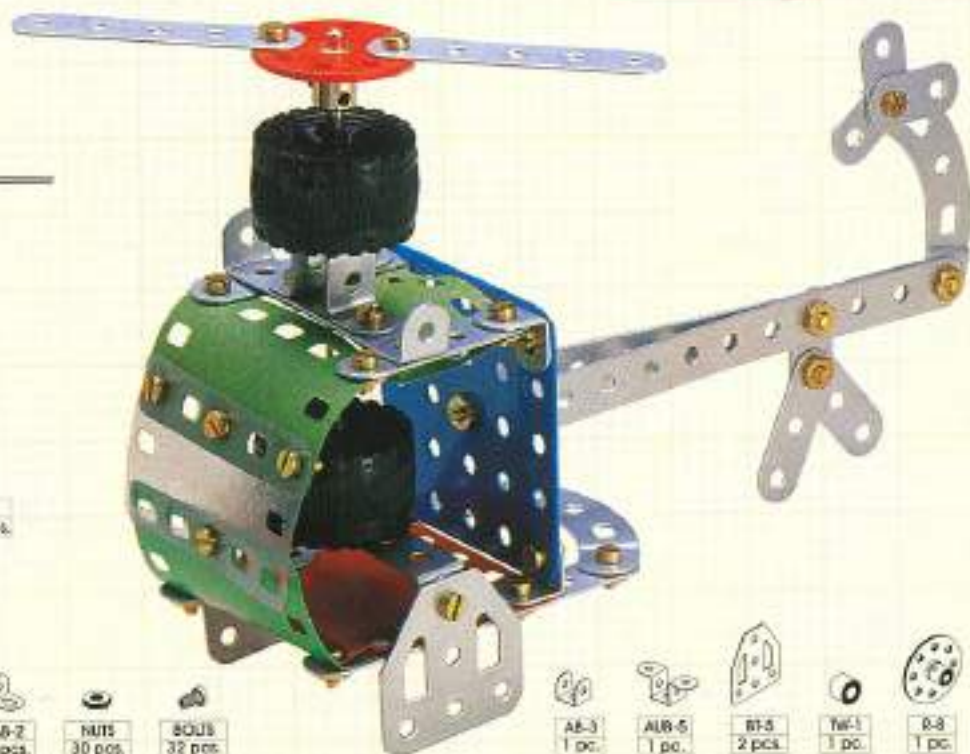

A-11 2 pcs. A-7 2 pcs. A-5 3 pcs.

A-4 2 pcs.

A-3 3 pcs.

A-2 4 pcs.

SH-2 1 pc.

SH-4 1 pc.

AB-2 6 pcs.

NUTS 26 pcs.

SOUS 26 pcs.

TW-1 4 pcs.

AB-3 1 pc.

AB-7 2 pcs.

BT-5 2 pcs.

PSR-12 1 pc.

PSR-20 1 pc.

WHEEL 4 pcs.

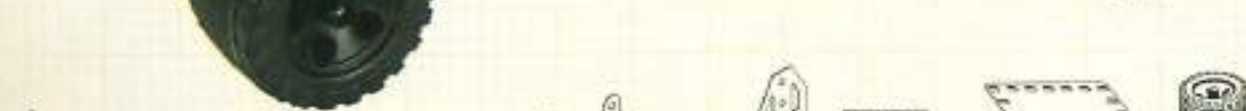

AB-2 6 pcs. NUTS 26 pcs. SOUS 26 pcs. TW-1 4 pcs. AB-3 1 pc. AB-7 2 pcs. BT-5 2 pcs. PSR-12 1 pc. PSR-20 1 pc. WHEEL 4 pcs.

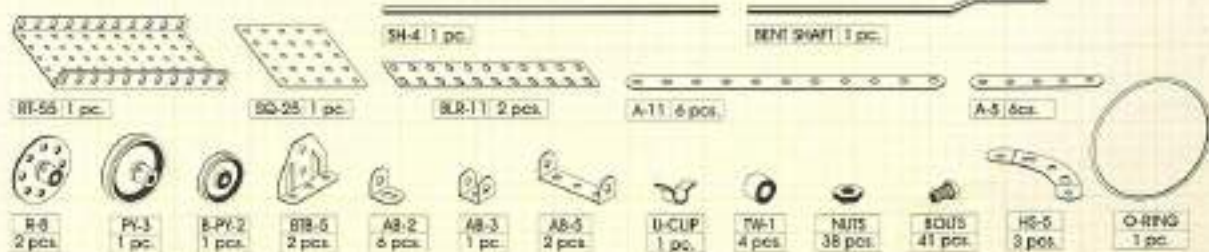
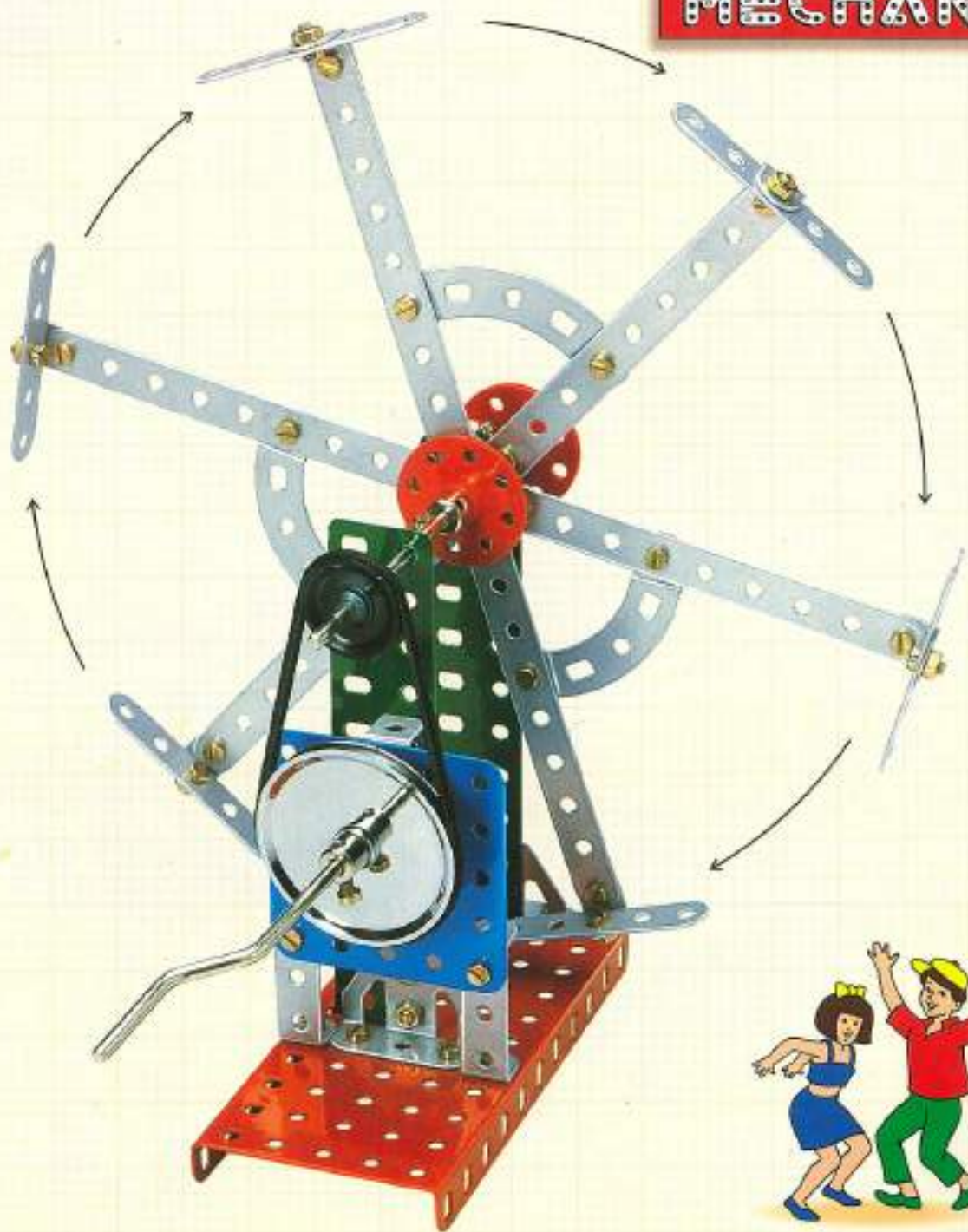

- A-3 2 pcs.
- A-4 4 pcs.
- A-5 7 pcs.
- A-11 4 pcs.

- A-7 4 pcs.
- BH-1 2 pcs.
- BH-2 2 pcs.
- BH-4 3 pcs.
- BENT SHAFT 1 pc.

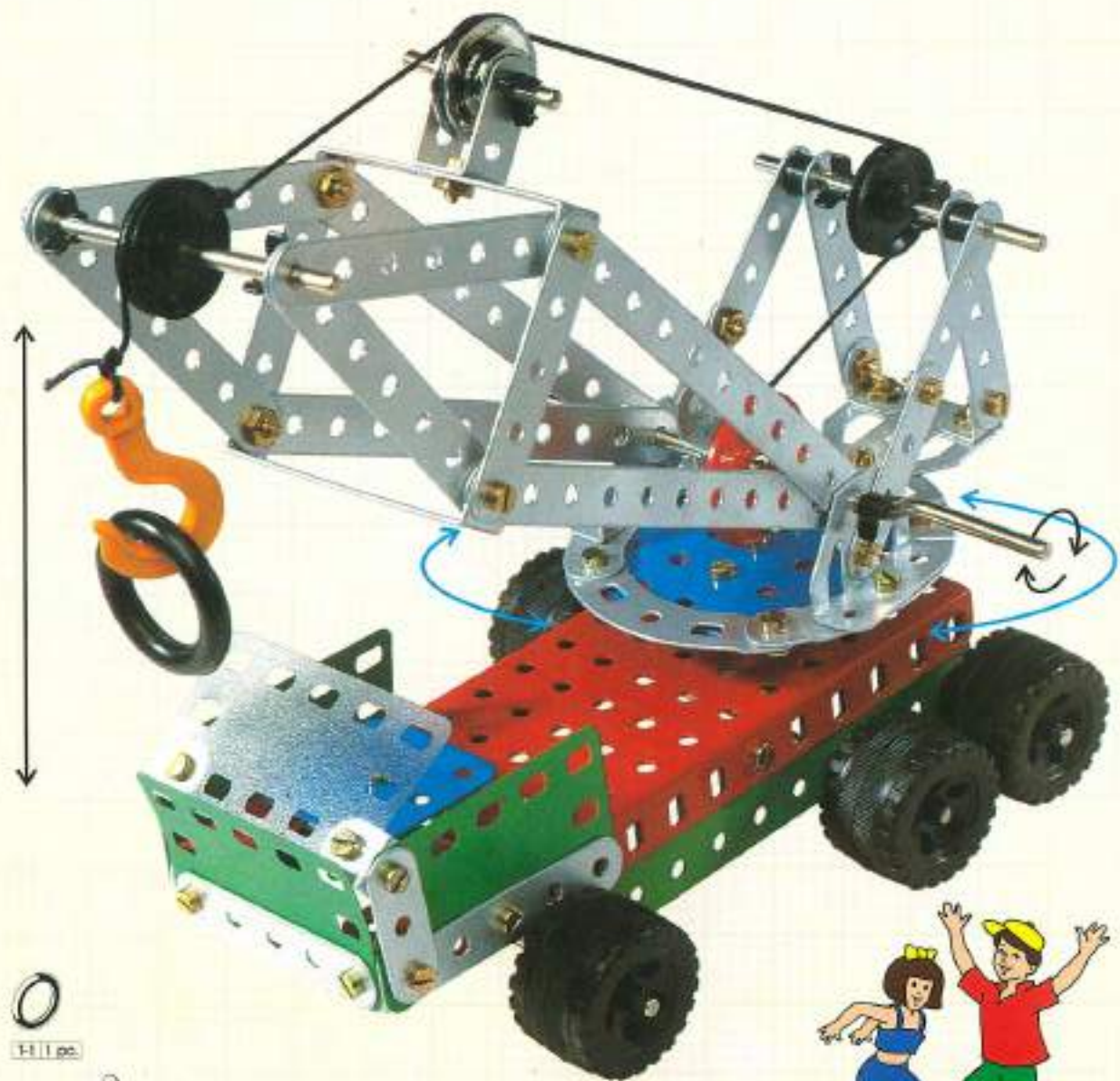

- F-1 1 pc.

- AB-7 2 pcs.
- BS-6 4 pcs.
- VS-2 2 pcs.
- BR-13 2 pcs.

- RS-5 1 pc.
- SQ-25 1 pc.
- BT-5 1 pc.
- BT-6 2 pcs.
- PSR-12 3 pcs.
- PSR-12 (transp.) 1 pc.
- SQ-9 1 pc.
- THREAD 1 pc.
- H-1 1 pc.

- P-8 2 pcs.
- PV-3 1 pc.
- 8-PV-3 2 pcs.
- PV-2 1 pc.
- AB-2 6 pcs.
- AB-3 2 pcs.
- A25-3 1 pc.
- A18-5 1 pc.
- U-CUP 6 pcs.
- WA-1 6 pcs.
- NUTS 40 pcs.
- BEHLS 37 pcs.
- LONG BOLT 6 pcs.
- WHEEL 6 pcs.



-  A-2 2 pos.
-  A-3 2 pos.
-  A-4 2 pos.
-  A-5 2 pos.
-  A-7 4 pos.
-  A-11 4 pos.
-  SH-1 1 pc.
-  SH-3 1 pc.

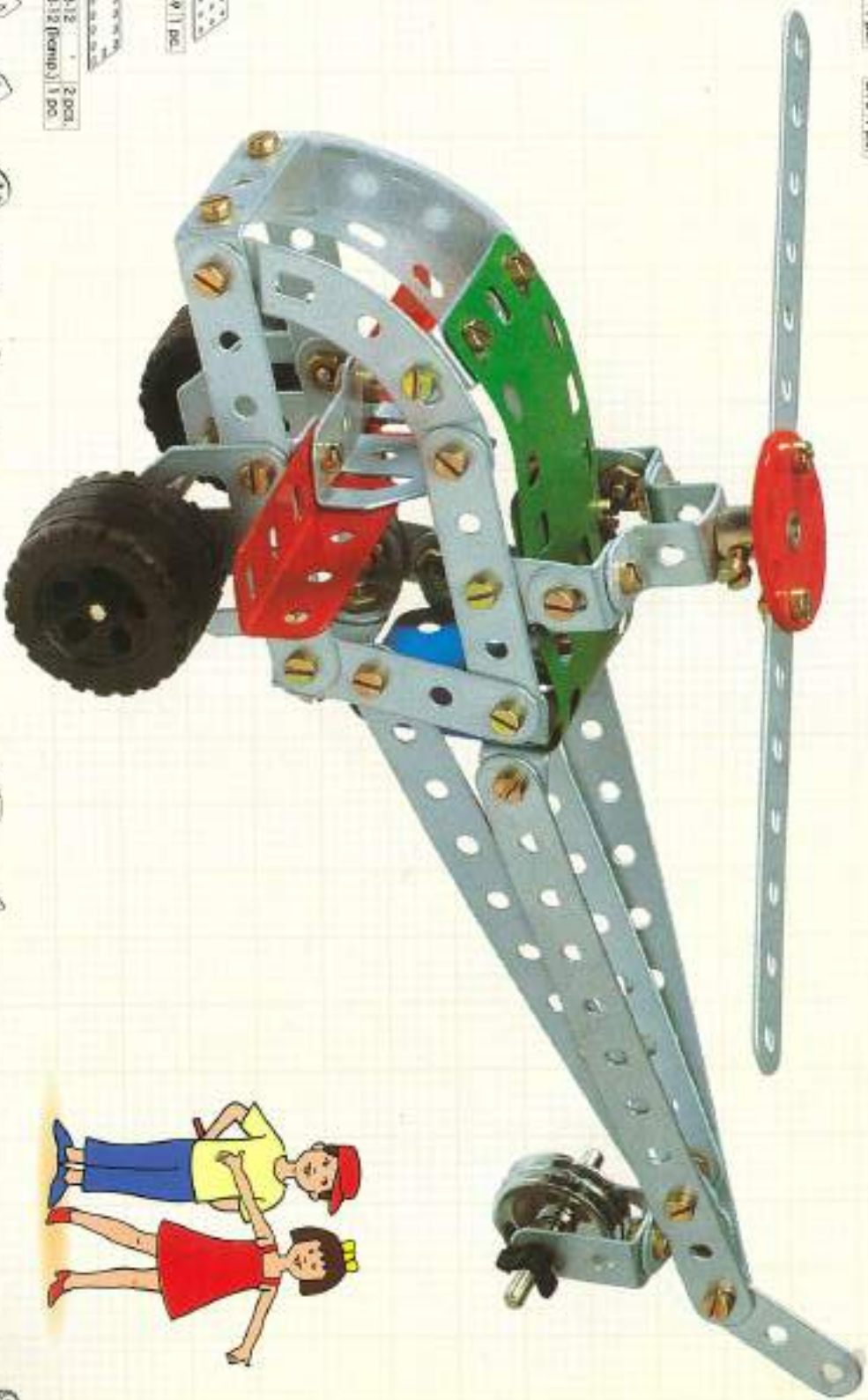

-  PSB-12 2 pos.
-  PSB-12 (comp.) 1 pc.
-  36x9 1 pc.
-  8H-5 2 pos.
-  8H-5 1 pc.
-  8-8 1 pc.
-  T-2 2 pos.
-  A4-5 1 pc.
-  A4-5 1 pc.
-  A4-5 1 pc.
-  A4-5 1 pc.
-  A4-5 2 pos.
-  A4-5 2 pos.
-  A4-5 2 pos.
-  A4-5 2 pos.
-  A4-5 2 pos.
-  A4-5 2 pos.
-  A4-5 2 pos.
-  A4-5 2 pos.
-  A4-5 2 pos.
-  A4-5 2 pos.
-  A4-5 2 pos.
-  A4-5 2 pos.
-  A4-5 2 pos.
-  A4-5 2 pos.
-  A4-5 2 pos.
-  A4-5 2 pos.



- BR-59 1 pc.
- BR-5 2 pcs.
- BR-5 2 pcs.
- AR-7 2 pcs.
- BR-4 1 pc.
- PR-2 1 pc.
- PR-1 2 pcs.

- 9-CUP5 2 pcs.
- AV-3 3 pcs.
- AV-2 10 pcs.
- TA-1 4 pcs.
- NRB 38 pcs.
- BOLE 36 pcs.
- ICMG FOOT 2 pcs.
- AA-5 1 pc.
- WHS 4 pcs.

- A-2 3 pcs.
- A-5 7 pcs.
- SH-1 1 pc.
- SH-4 2 pcs.
- BR-12 2 pcs.
- PR-12 (Internal) 1 pc.

46-48-50
A.1 2 pcs
A.5 8 pcs

3H.1 1 pc.

3H.2 1 pc.

3H.3 1 pc.

3G.2B.1 1 pc.

V.6 2 pcs.

91P.20 1 pc.

B1.5
2 pcs.

B3.5
2 pcs.

B.8
2 pcs.

PV.1
2 pcs.



MECHANIX

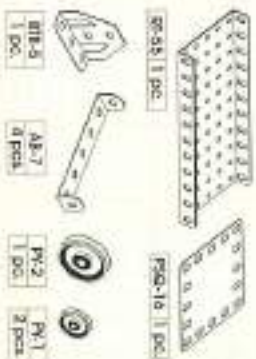

- A.2 15 pcs.
- A.3 2 pcs.
- A.4 4 pcs.
- A.5 8 pcs.
- A.7 4 pcs.
- A.11 5 pcs.

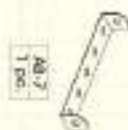
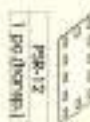
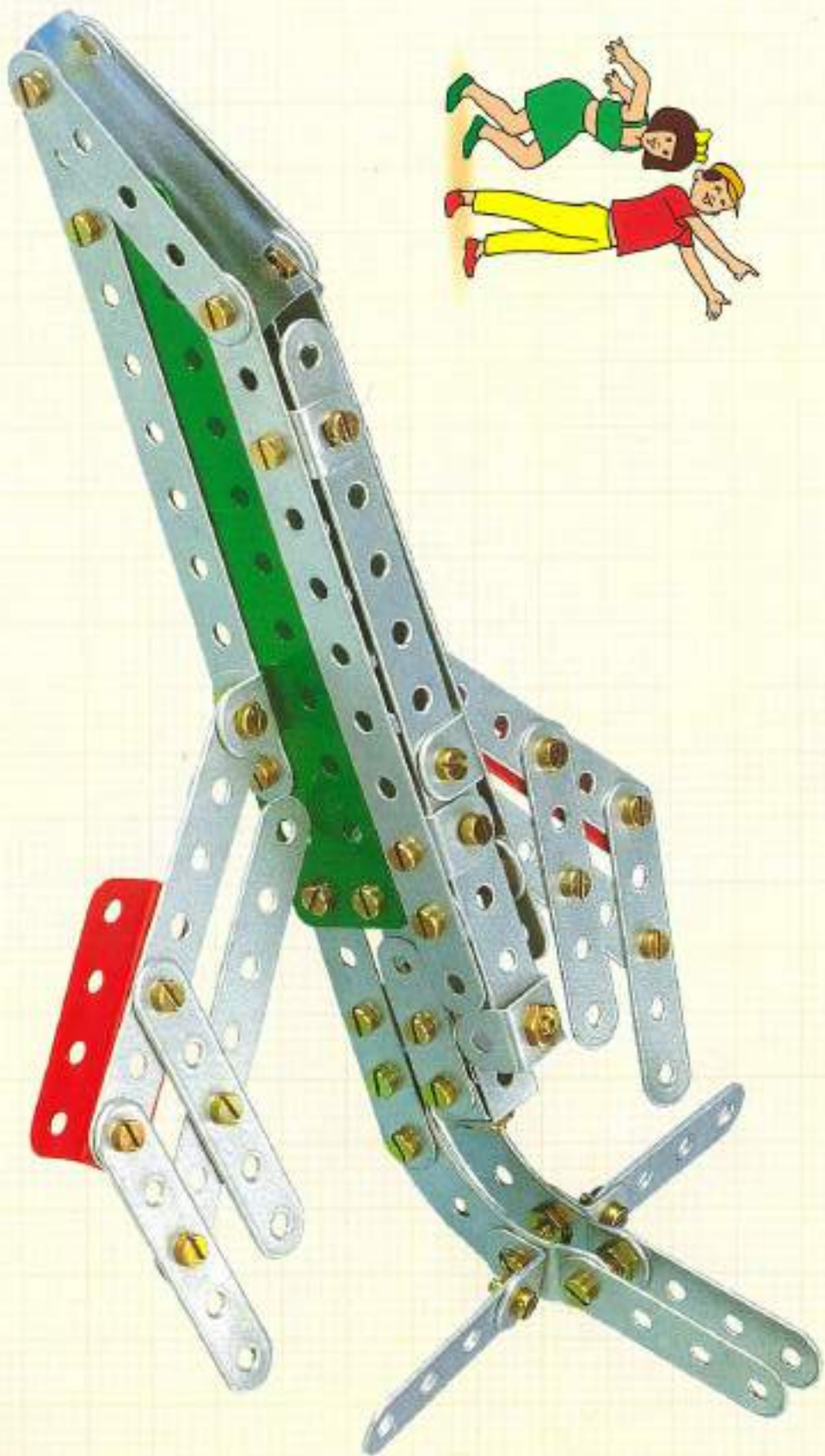

A-2 1 pc. A-3 1 pc. A-4 1 pc. A-5 1 pc. A-6 1 pc. A-7 1 pc.

A-11 2 pc. SH-1 2 pc. SH-2 2 pc. SH-3 1 pc.

AB-2 5 pc. SH-4 3 pc. SH-5 SHAFT 1 pc.

VA-1 1 pc. AB-5 1 pc.

AB-7 2 pc. AB-5 1 pc.

HS-5 4 pc. SO-9 1 pc.

PS-90 1 pc.

RS-11 2 pc.

SO-25 1 pc. R-8 2 pc.

BR-3 2 pc. PW-3 1 pc. PW-2 2 pc. 3 PW-2 2 pc. PW-1 1 pc. TW-1 2 pc. UC-1P 11 pc. NUTS 55 pc.

FR-50 1 pc. SOUS 51 pc. LONG ROD 7 pc. WHEEL 6 pc.

O-RING 1 pc.

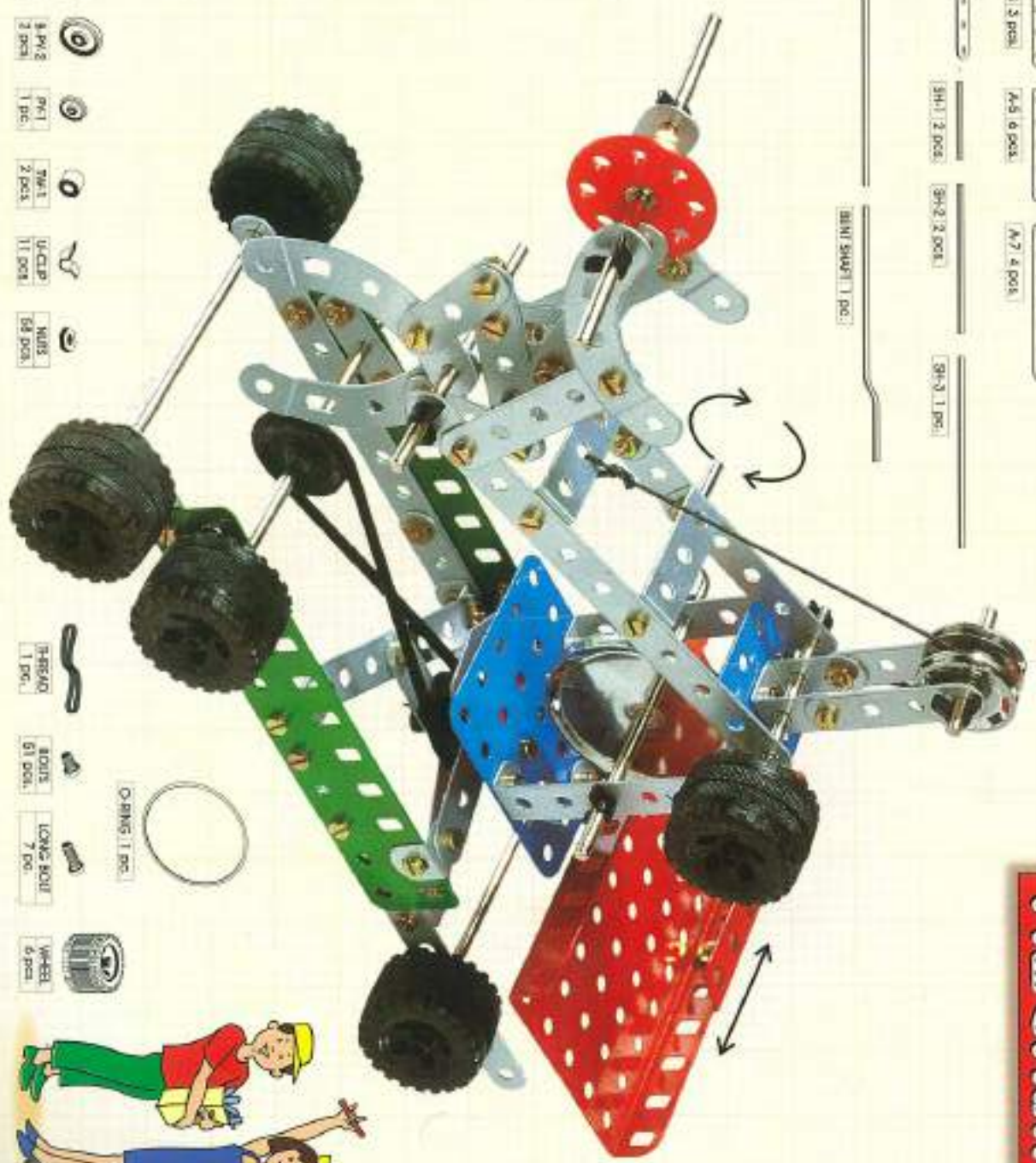

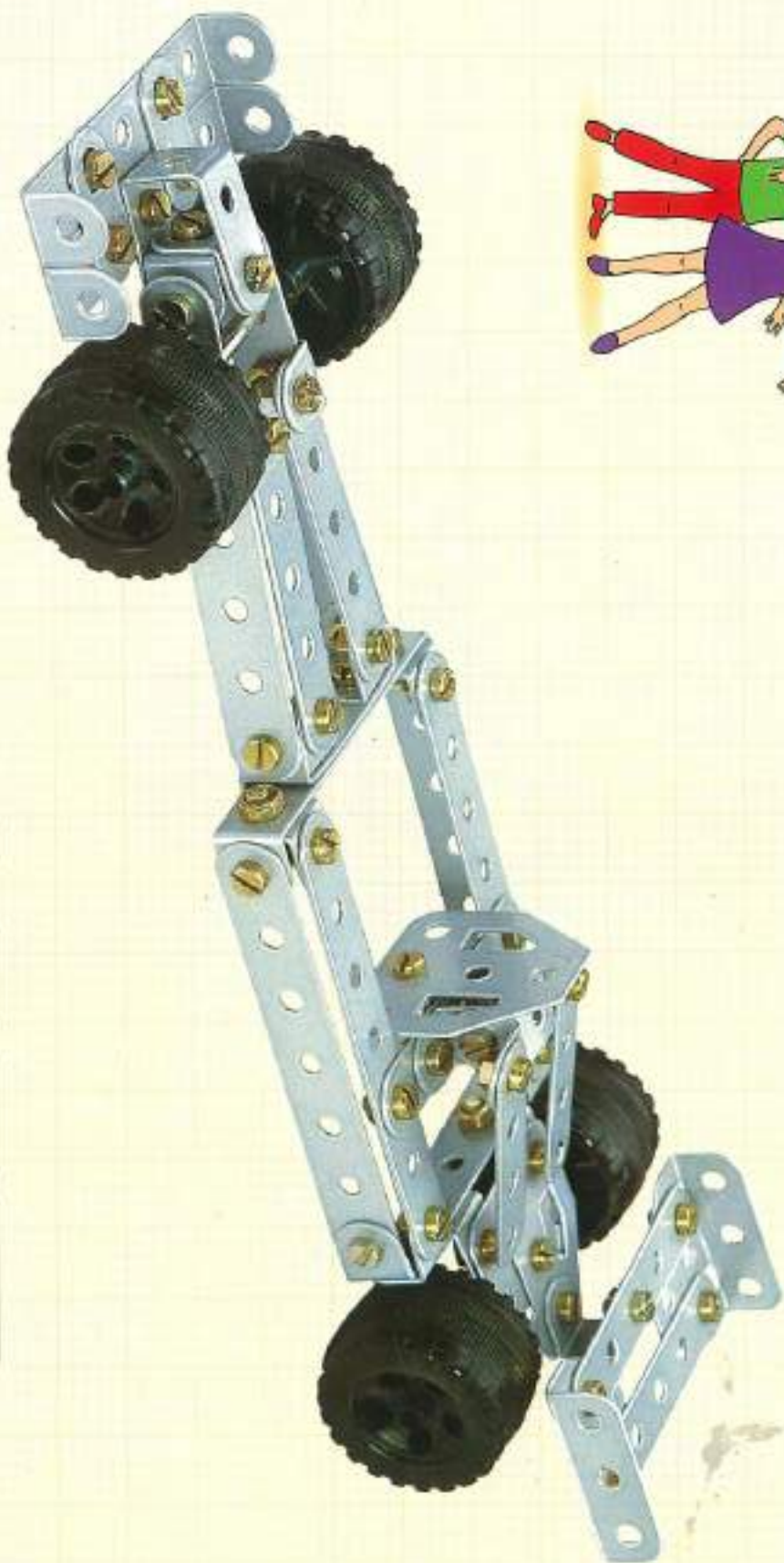

31-5
2 pcs.



31b-5
2 pcs.



A1-7
4 pcs.



A1-5
2 pcs.



A25-3
2 pcs.



A18-5
1 pc.



A12-5
1 pc.



A2-3
2 pcs.



A6-2
12 pcs.



T1-1
2 pcs.



N15
54 pcs.



K15
50 pcs.



30MG BOLT
2 pcs.



WHEEL
4 pcs.

A2 2 pcs.

A4 3 pcs.

A5 5 pcs.

A7 6 pcs.

SH 2 2 pcs.

- A-2 2 pin
- A-3 2 pins
- A-4 1 pin
- A-6 9 pins
- A-7 9 pins
- A-11 4 pins

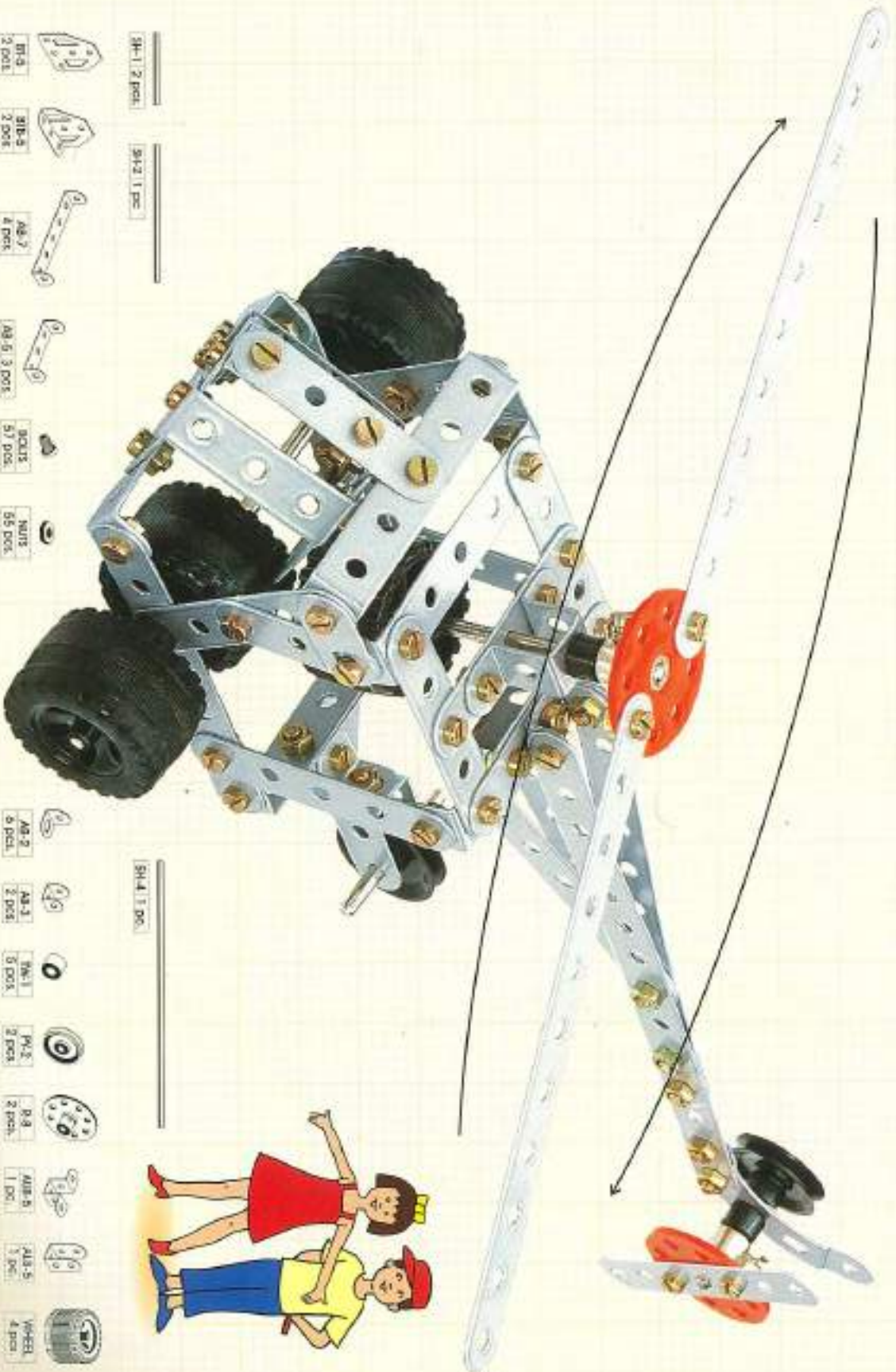

- SH-1 2 pins
- SH-2 1 pin

- B1-3 2 pins
- B1B-5 2 pins
- A8-7 8 pins
- A8-5 3 pins
- BOULTS 57 pins
- NUTS 55 pins

- SH-4 1 pin

- A8-2 6 pins
- A8-3 2 pins
- SH-1 8 pins
- P1-5 2 pins
- B-8 2 pins
- A8B-5 1 pin
- A1S-5 3 pins
- WHEEL 4 pins



- A-3 4 pcs.
- A-5 9 pcs.
- A-7 3 pcs.

- A-11 5 pcs.

- SH-2 1 pc.

- SH-4 3 pcs.

- BENT SHAFT 1 pc.

- PS-12 1 pc.
- PS-12 (short) 1 pc.

- SO-25 1 pc.

- PS-16 3 pcs.

- PS-20 1 pc.

- BR-11 3 pcs.

- BE-05 1 pc.

- BR-5 2 pcs.
- BR-6 2 pcs.
- BR 2 pcs.
- PC-3 1 pc.
- PC-2 2 pcs.
- BRV-2 1 pc.
- PV-1 1 pc.
- HS-5 4 pcs.
- AB-7 2 pcs.
- AB-6 2 pcs.
- AB-8 1 pc.
- AB-3 1 pc.
- AB-2 10 pcs.
- U-CLIPS 2 pcs.
- TW-1 4 pcs.
- NUTS 53 pcs.
- BOLTS 48 pcs.
- LOWER SCREW 6 pcs.
- WHEEL 6 pcs.

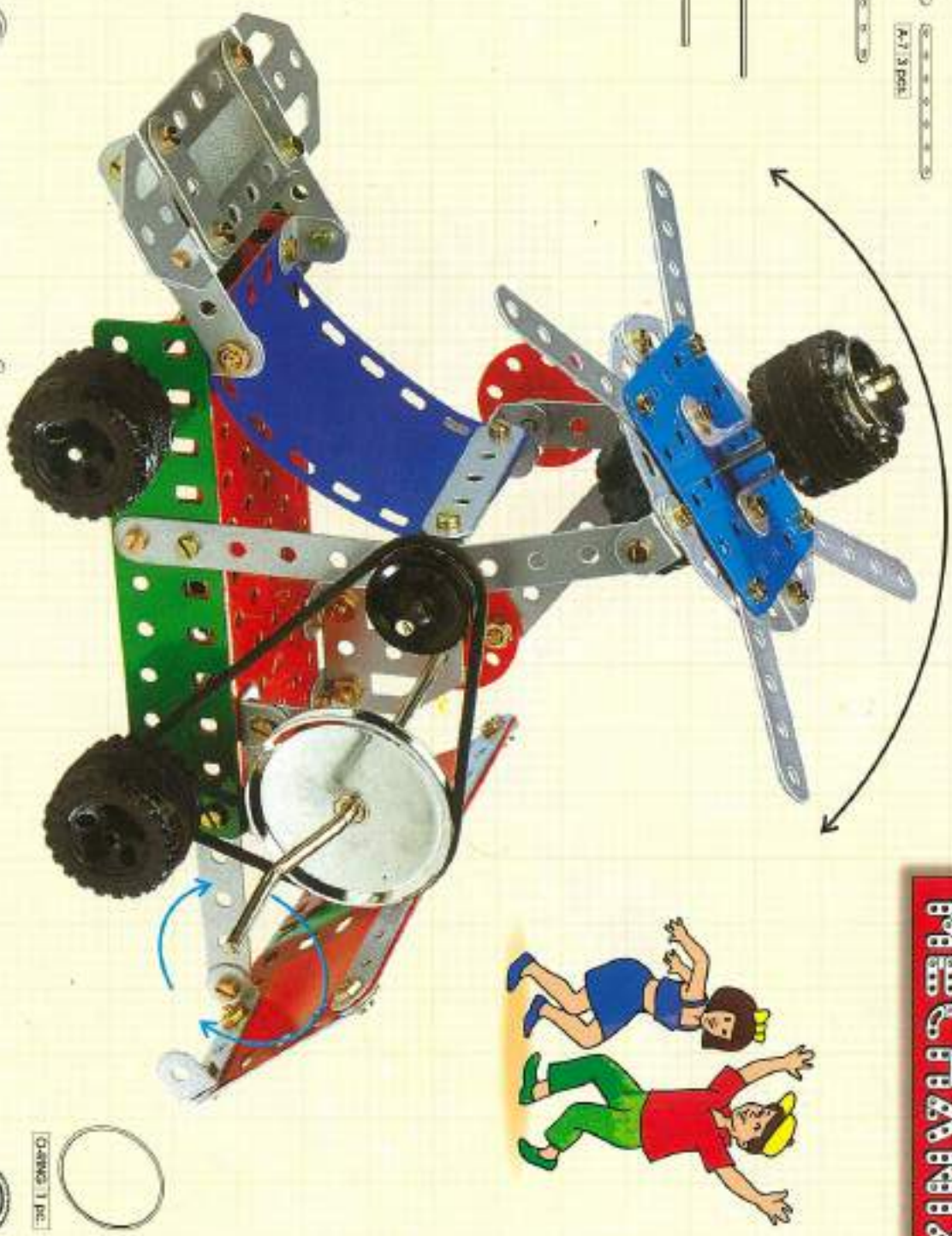

- GAMES 1 pc.

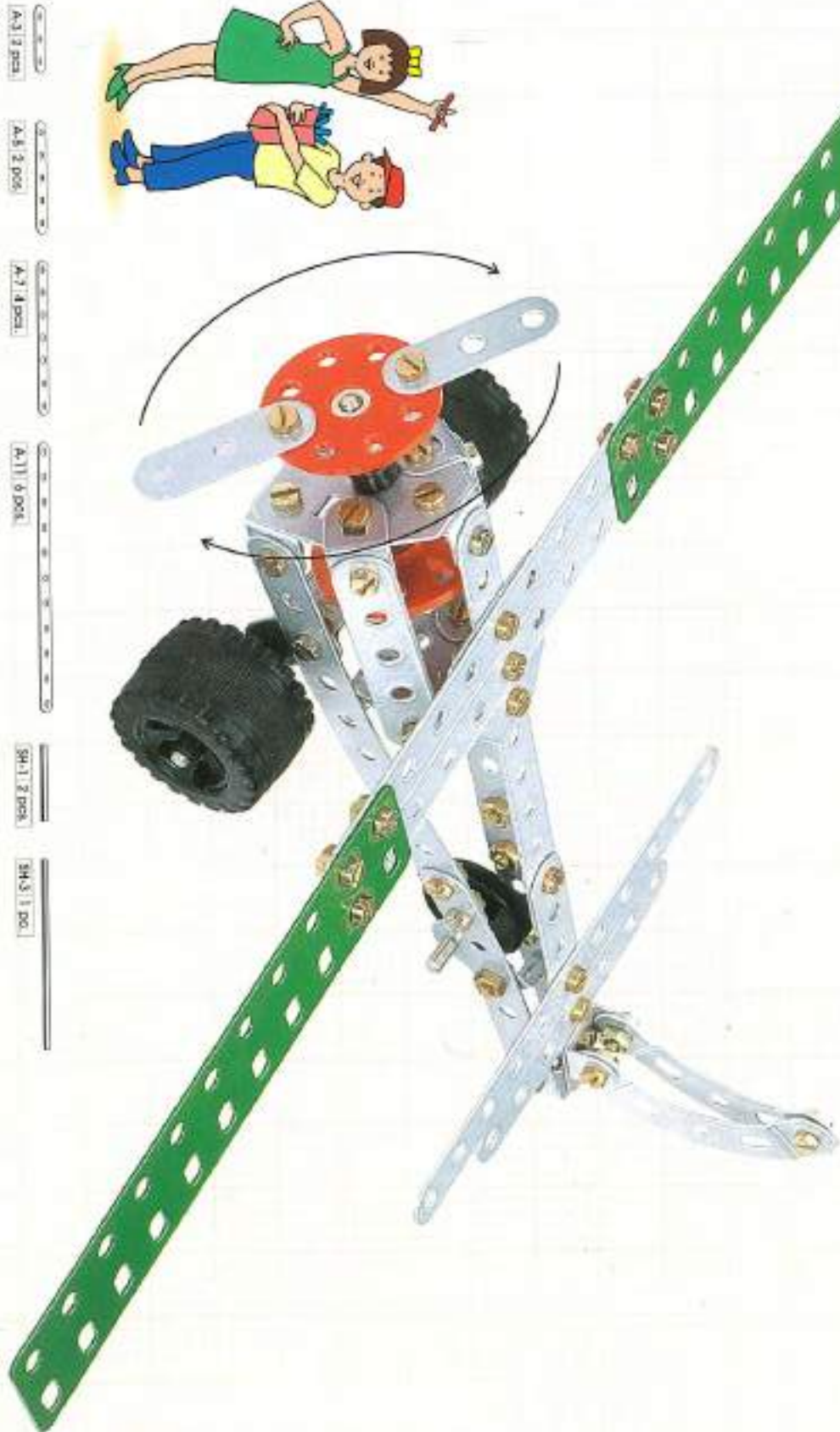
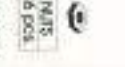
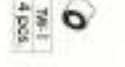
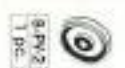
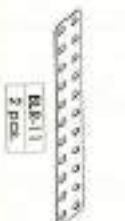
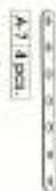
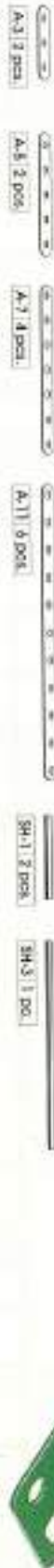

ALSO FROM THE HOUSE OF

ZEPHYR

AGE
3+

A PLASTIC ENGINEERING CONSTRUCTION SET



MECHANIX
(GRAND PRIX-CARS 1)
4 MODELS - 57 PCS.



MECHANIX
(PLANES-1)
4 MODELS - 57 PCS.



MECHANIX
(GRAND PRIX-CARS 2)
7 MODELS - 81 PCS.



MECHANIX
(AVIONIX - PLANES 2)
7 MODELS - 81 PCS.



MECHANIX
(CARS-2)
15 MODELS - 175 PCS.



MECHANIX
(MOBITECH)
14 MODELS - 110 PCS.



MECHANIX
(PLANES-3)
15 MODELS - 180 PCS.

AGE
7+

All

METAL ENGINEERING CONSTRUCTION SETS



MECHANIX-0
5 MODELS - 73 PCS.

MECHANIX-3
20 MODELS - 201 PCS.



MECHANIX-2
15 MODELS - 120 PCS.



MECHANIX-1
10 MODELS - 92 PCS.

Awarded

"The Best Toy" &

"The Best Educational Toy"

by The All India Toy Manufacturers Association

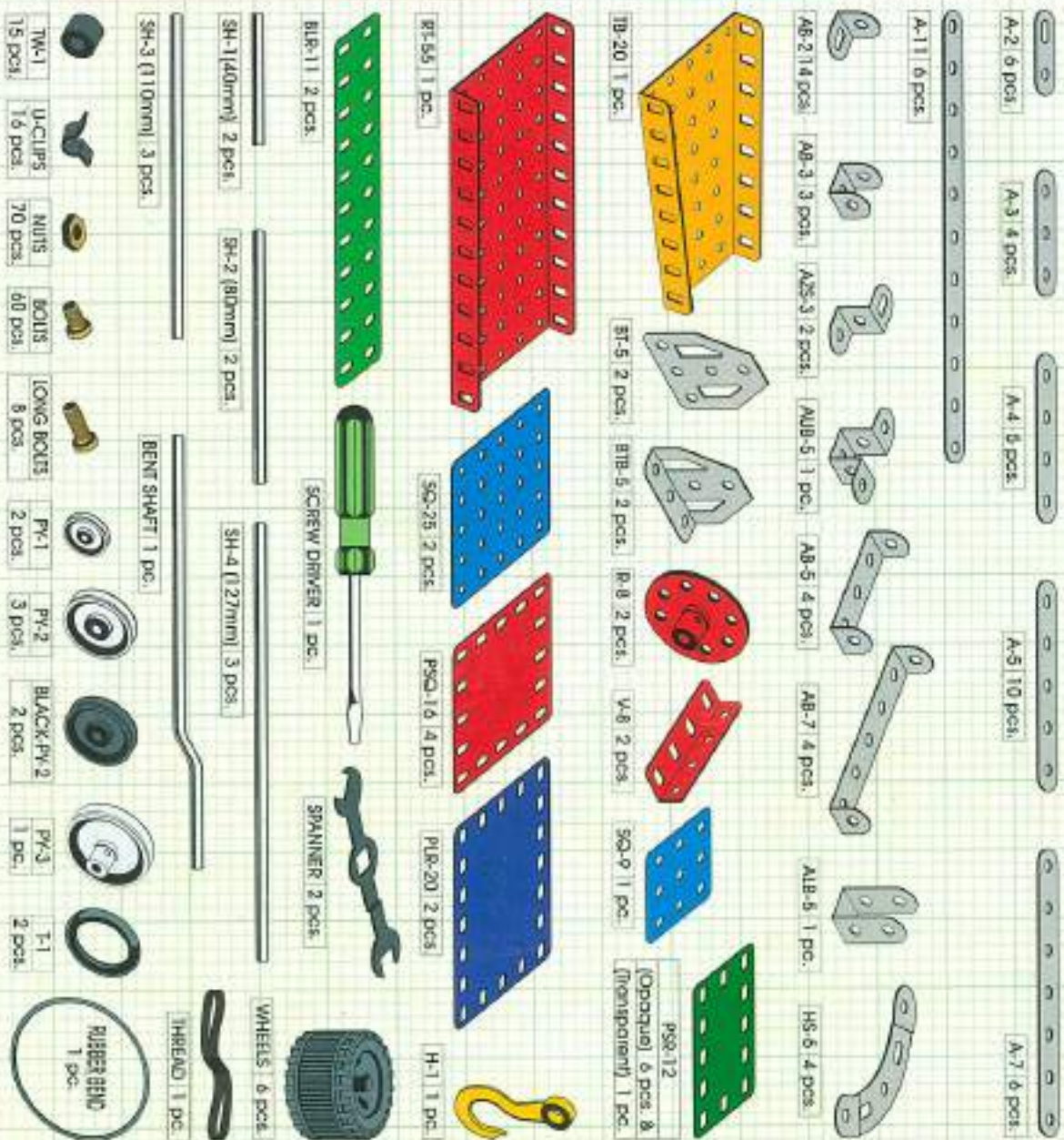

That fresh smile and laughter, giggles and chattering of the little kids are one of the most refreshing happiness that touches the heart. Like the cool evening breeze on the rise that refreshes the soul of a worked up being.

That is what Zephyr is all about and about quality, in the true sense of the word. Quality of play, quality of education and quality of product.

We bring you a whole range of play and educational toys of international standards that undergo through the strict quality control of the Zephyr family itself.

Our kids have won quite a few awards and Mechanix is our star set that has won "The Best Educational Toy" and "The Best Toy" award at the TATMA.

We do not do business, at Zephyr's we befriend children. A smile on your child's face is our gain.

Love

ZEPHYR

ZEPHYR TOYMAKERS PVT. LTD.

A-51, TTC Ind Area, Mahape,
 Navi Mumbai - 401716.
 www.zephyrtoy.com | Join us on
 facebook.com/zephyrtoy
 E-mail: feedback@zephyr.in